

# **dji** LITO X1

## User Manual

v1.0 2026.04





This document is copyrighted by DJI with all rights reserved. Unless otherwise authorized by DJI, you are not eligible to use or allow others to use the document or any part of the document by reproducing, transferring or selling the document. Only refer to this document and the content thereof as instructions to operate DJI products. The document should not be used for other purposes.

In the event of divergence among different versions, the English version shall prevail.

### **Searching for Keywords**

Search for keywords such as “battery” and “install” to find a topic. If you are using Adobe Acrobat Reader to read this document, press Ctrl+F on Windows or Command+F on Mac to begin a search.

### **Navigating to a Topic**

View a complete list of topics in the table of contents. Click on a topic to navigate to that section.

### **Printing this Document**

This document supports high resolution printing.

# Using this Manual

## Legend

⚠ Important

💡 Hints and Tips

📖 Reference

## Read Before Use

DJI™ provides you with tutorial videos and the following documents:

1. *Safety Guidelines*
2. *Quick Start Guide*
3. *User Manual*

It is recommended to watch all the tutorial videos and read the *Safety Guidelines* before using for the first time. Make sure to review the *Quick Start Guide* before using for the first time and refer to this *User Manual* for more information.

## Video Tutorials

Go to the address below or scan the QR code to watch the tutorial videos, which demonstrate how to use the product safely:



<https://www.dji.com/lito-x1/video>

## Download the DJI Fly App

Make sure to use DJI Fly during flight. Scan the QR code to download the latest version.



-  The remote controller with screen has the DJI Fly app already installed. You are required to download DJI Fly to your mobile device when using the remote controller without screen.
  - To check the Android and iOS operating system versions supported by DJI Fly, visit <https://www.dji.com/downloads/djiapp/dji-fly>.
  - The interface and functions of DJI Fly may vary as the software version is updated. Actual user experience is based on the software version used.
  - For increased safety, flight is restricted to a height of 98.4 ft (30 m) and a range of 164 ft (50 m) when not connected or logged into the app during flight.
  - App login is valid for 90 days. Connect to the internet and log in again when expired.
- 

## Download DJI Assistant 2

Download DJI ASSISTANT™ 2 (Consumer Drones Series) at:

<https://www.dji.com/downloads/softwares/dji-assistant-2-consumer-drones-series>

---

-  The operating temperature of this product is -10° to 40° C. It does not meet the standard operating temperature for military-grade application (-55° to 125° C), which is required to endure greater environmental variability. Operate the product appropriately and only for applications that meet the operating temperature range requirements of that grade.
-

# Contents

<b>Using this Manual</b>	<b>3</b>
Legend	3
Read Before Use	3
Video Tutorials	3
Download the DJI Fly App	3
Download DJI Assistant 2	4
<b>1 Product Profile</b>	<b>10</b>
1.1 Using for the First Time	10
Preparing the Aircraft	10
Preparing the Remote Controller	12
DJI RC 2	12
DJI RC-N3	13
Activation	13
Binding the Aircraft and Remote Controller	14
Firmware Update	14
1.2 Overview	14
Aircraft	14
DJI RC 2 Remote Controller	15
DJI RC-N3 Remote Controller	16
<b>2 Flight Safety</b>	<b>18</b>
2.1 Flight Restrictions	18
GEO (Geospatial Environment Online) System	18
Flight Limits	18
Flight Altitude and Distance Limits	18
GEO Zones	19
Unlocking GEO Zones	20
2.2 Flight Environment Requirements	20
2.3 Operating the Aircraft Responsibly	21
2.4 Pre-Flight Checklist	22
<b>3 Basic Flight</b>	<b>25</b>
3.1 Auto Takeoff/Landing	25
Auto Takeoff	25
Auto Landing	25
3.2 Starting/Stopping the Motors	25
Starting the Motors	25
Stopping the Motors	25
Stopping the Motors Mid-Flight	26

3.3	Controlling the Aircraft	26
3.4	Takeoff/Landing Procedures	27
3.5	Recording Audio via App	28
3.6	Video Suggestions and Tips	28
<b>4</b>	<b>Intelligent Flight Modes</b>	<b>31</b>
4.1	FocusTrack	31
	Notice	32
	Using FocusTrack	33
4.2	MasterShots	33
	Notice	34
	Using MasterShots	34
4.3	QuickShots	34
	Notice	35
	Using QuickShots	35
4.4	Hyperlapse	36
	Using Hyperlapse	36
4.5	Waypoint Flight	36
	Using Waypoint Flight	37
4.6	Cruise Control	37
	Using Cruise Control	37
<b>5</b>	<b>Aircraft</b>	<b>39</b>
5.1	Flight Mode	39
5.2	Aircraft Status Indicators	40
5.3	Return to Home	41
	Notice	42
	Advanced RTH	43
	Trigger Method	43
	RTH Procedure	45
	RTH Settings	46
	Landing Protection	48
	Dynamic Home Point	49
5.4	Sensing System	50
	Notice	51
5.5	Advanced Pilot Assistance Systems	52
	Notice	53
	Landing Protection	53
5.6	Vision Assist	54
5.7	Propellers	55
	Attaching/Detaching the Propellers	55
	Notice	56

5.8	Intelligent Flight Battery	57
	Notice	57
	Installing/Removing the Battery	58
	Using the Battery	58
	Charging the Battery	60
	Using a Charger	60
	Using the Charging Hub	60
	Battery Protection Mechanisms	64
5.9	Gimbal and Camera	64
	Gimbal Notice	64
	Gimbal Angle	65
	Gimbal Operation Modes	66
	Camera Notice	66
5.10	Storing and Exporting Photos and Videos	67
	Storing	67
	Exporting	67
5.11	QuickTransfer	68
<b>6</b>	<b>Remote Controller</b>	<b>71</b>
6.1	DJI RC 2	71
	Operations	71
	Powering On/Off	71
	Charging the Battery	71
	Controlling the Gimbal and Camera	72
	Flight Mode Switch	72
	Flight Pause/RTH Button	72
	Remote Controller LEDs	73
	Status LED	73
	Battery Level LEDs	73
	Remote Controller Alert	73
	Optimal Transmission Zone	74
	Linking the Remote Controller	74
	Operating the Touchscreen	75
6.2	DJI RC-N3	77
	Operations	77
	Powering On/Off	77
	Charging the Battery	77
	Controlling the Gimbal and Camera	77
	Flight Mode Switch	78
	Flight Pause/RTH Button	78
	Battery Level LEDs	78
	Remote Controller Alert	79

Optimal Transmission Zone	79
Linking the Remote Controller	80
<b>7 Appendix</b>	<b>82</b>
7.1 Specifications	82
7.2 Compatibility	82
7.3 Firmware Update	82
7.4 Flight Recorder	83
7.5 Post-Flight Checklist	83
7.6 Maintenance Instructions	83
7.7 Troubleshooting Procedures	84
7.8 Risks and Warnings	85
7.9 Disposal	85
7.10 C0 and C1 Certification	85
Direct Remote ID	87
Remote Controller Warnings	87
GEO Awareness	88
<b>GEO Zones</b>	89
EASA Notice	91
Original Instructions	91
7.11 Aftersales Information	91

# Product Profile

---

# 1 Product Profile

## 1.1 Using for the First Time

Click the link or scan the QR code to watch the tutorial videos.



<https://www.dji.com/lito-x1/video>

### Preparing the Aircraft

1. Remove the gimbal protector from the camera.

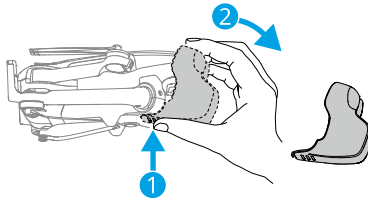

2. Press the power button once to activate the battery.

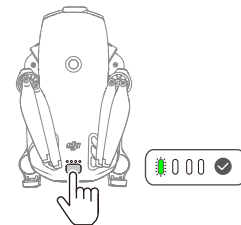

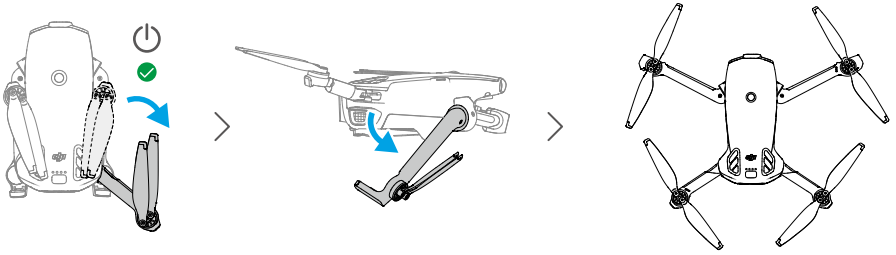

3. Unfold the aircraft arms as shown.

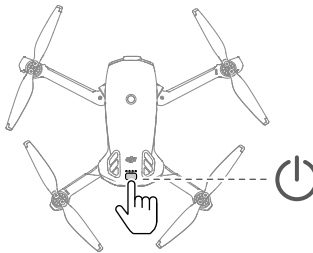

- **Automatic Power-On:** Unfolding the right rear arm will power on the aircraft by default.
  - **Automatic Power-Off:** Folding the right rear arm will initiate an automatic countdown for power-off. To cancel the power-off during the countdown, press the power button once.
- 
-  The **Unfold Arm to Power on** feature is enabled by default. The **Fold Arm to Power off** feature is disabled by default. Enable or disable the feature in DJI Fly when the aircraft is connected to the remote controller. Make sure that the aircraft firmware, battery firmware, and the app are updated to the latest version. Otherwise, the feature may not be available.

- **Manual Power-On/Power-Off:** Press, then press and hold the power button to power on or off the aircraft.



-  If the aircraft does not take off after activating the battery, the battery will enter sleep mode again after the aircraft powers off for a period of time. In this case, press the power button or charge the battery to activate it again before using the **Unfold Arm to Power on** feature.

- When the USB-C port of the aircraft is in use, unfolding the arm will not power on the aircraft. Disconnect the USB-C connection, and wait for a few seconds before using the Unfold Arm to Power on feature.
- If the aircraft is currently accessing the album, downloading materials, or updating firmware, folding the arm will not power off the aircraft.
- If a collision occurs during flight, the automatic power-off feature will not function. The feature is available after the aircraft is restarted.

- 
-  • It is recommended to use the DJI charger to charge the Intelligent Flight Battery. Visit the official DJI website for details.
- Make sure the gimbal protector is removed and all arms are unfolded before powering on the aircraft. Otherwise, it may affect the aircraft self-diagnostics.
  - It is recommended to attach the gimbal protector when the aircraft is not in use.
- 

## Preparing the Remote Controller

### DJI RC 2

1. Remove the control sticks from the storage slots and mount them on the remote controller.

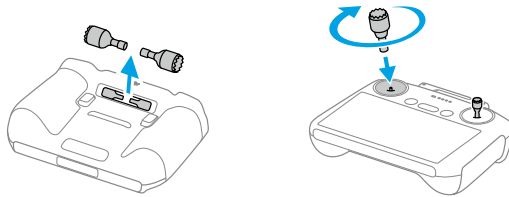

2. Unfold the antennas.

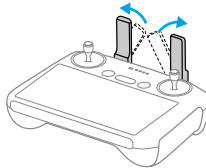

3. The remote controller needs to be activated before first use and an internet connection is required for activation. Press, then press and hold the power button to power on the remote controller. Follow the on-screen prompts to activate the remote controller.

## DJI RC-N3

1. Remove the control sticks from the storage slots and mount them on the remote controller.
2. Pull out the mobile device holder. Choose the appropriate remote controller cable based on the port type of your mobile device (the cable with a USB-C connector is connected by default). Place your mobile device in the holder, then connect the end of the cable without the remote controller logo to your mobile device. Make sure your mobile device is securely in place.

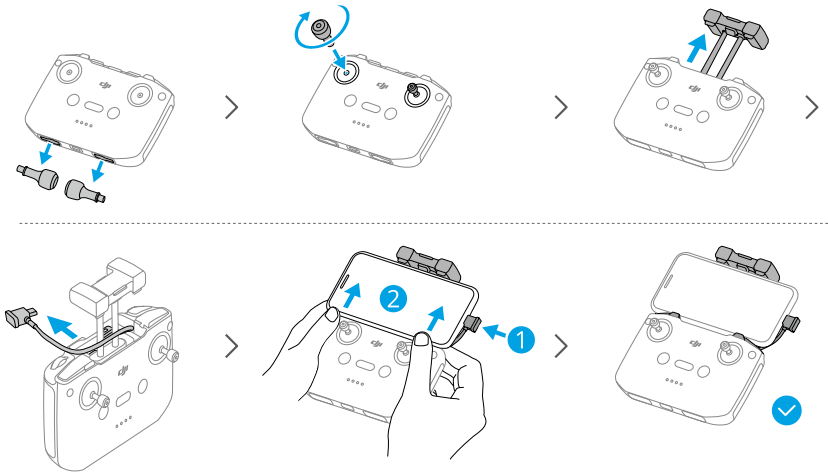

- 
- ⚠** • If a USB connection prompt appears when an Android mobile device is used, select the option to charge only. Other options may cause the connection to fail.
- Adjust the mobile device holder to make sure your mobile device is firmly secure.
- 

## Activation

The aircraft requires activation before first use. Press, then press and hold the power button to power on the aircraft and remote controller respectively, and then follow the on-screen prompts to activate the aircraft using DJI Fly. An internet connection is required for activation.

## Binding the Aircraft and Remote Controller

After activation, the aircraft is bound to the remote controller automatically. If automatic binding fails, follow the on-screen prompts on DJI Fly to bind the aircraft and remote controller for an optimal warranty service experience.

## Firmware Update

A prompt will appear in DJI Fly when a firmware update is available. Update the firmware whenever prompted. Otherwise, some features may not be available.

### 1.2 Overview

#### Aircraft

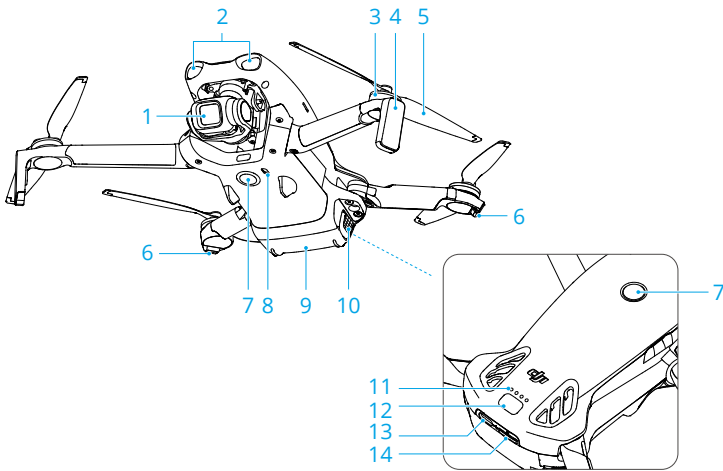

- 1. Gimbal and Camera
- 2. Forward-Facing LiDAR <sup>[1]</sup>
- 3. Motors
- 4. Landing Gears (Built-in antennas)
- 5. Propellers
- 6. Aircraft Status Indicators
- 7. Omnidirectional Monocular Vision System <sup>[2]</sup>
- 8. Downward Infrared Sensing System
- 9. Intelligent Flight Battery
- 10. Battery Buckles
- 11. Battery Level LEDs
- 12. Power Button
- 13. USB-C Port
- 14. microSD Card Slot

- [1] The forward-facing LiDAR meets the human eye safety requirements for Class 1 laser products.
- [2] The omnidirectional monocular vision system can sense obstacles in horizontal directions and above.

## DJI RC 2 Remote Controller

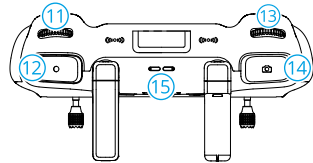
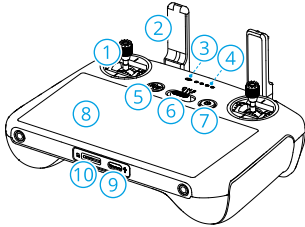

- 1. Control Sticks
- 2. Antennas
- 3. Status LED
- 4. Battery Level LEDs
- 5. Flight Pause/Return to Home (RTH) Button
- 6. Flight Mode Switch
- 7. Power Button
- 8. Touchscreen
- 9. USB-C Port
- 10. microSD Card Slot
- 11. Gimbal Dial
- 12. Record Button
- 13. Camera Control Dial <sup>[1]</sup>
- 14. Focus/Shutter Button
- 15. Speaker
- 16. Control Stick Storage Slots
- 17. Customizable C2 Button <sup>[1]</sup>
- 18. Customizable C1 Button <sup>[1]</sup>

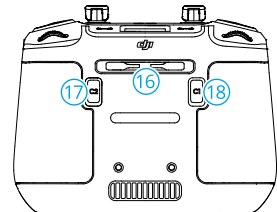

- [1] To view and set the button function, go to camera view in DJI Fly, and tap \*\*\* > Control > Button Customization.

## DJI RC-N3 Remote Controller

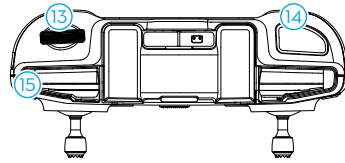
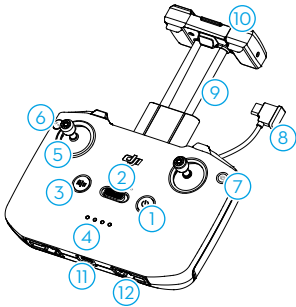

- |   |                                 |
|---|---------------------------------|
| 1. Power Button                             | 8. Remote Controller Cable      |
| 2. Flight Mode Switch                       | 9. Mobile Device Holder         |
| 3. Flight Pause/Return to Home (RTH) Button | 10. Antennas                    |
| 4. Battery Level LEDs                       | 11. USB-C Port                  |
| 5. Control Sticks                           | 12. Control Stick Storage Slots |
| 6. Customizable Button <sup>[1]</sup>       | 13. Gimbal Dial                 |
| 7. Photo/Video Button                       | 14. Shutter/Record Button       |
|   | 15. Mobile Device Slot          |
- [1] To view and set the button function, go to camera view in DJI Fly, and tap \*\*\* > Control > Button Customization.

# Flight Safety

---

## 2 Flight Safety

After completing pre-flight preparations, it is recommended to train your flying skills and practice flying safely. Pick a suitable area to fly in according to the following flight requirements and restrictions. Strictly abide by local laws and regulations when flying. Read the *Safety Guidelines* before flight to ensure safe use of the product.

### 2.1 Flight Restrictions

#### GEO (Geospatial Environment Online) System

The DJI Geospatial Environment Online (GEO) System is a global information system that provides real-time information on flight safety and restriction updates and prevents UAVs from flying in restricted airspace. Under exceptional circumstances, restricted areas can be unlocked to allow flights. Prior to that, you must submit an unlocking request based on the current restriction level in the intended flight area. The GEO system may not fully align with local laws and regulations. You are responsible for your own flight safety and must consult with the local authorities on the relevant legal and regulatory requirements before requesting to unlock a restricted area. For more information about the GEO system, visit <https://fly-safe.dji.com>.

#### Flight Limits

For safety reasons, flight limits are enabled by default to help you operate the aircraft safely. You can set flight limits on height and distance. Altitude limits, distance limits, and GEO zones function concurrently to manage flight safety when Global Navigation Satellite System (GNSS) is available. Only altitude can be limited when GNSS is unavailable.

#### Flight Altitude and Distance Limits

Max altitude restricts the flight altitude of the aircraft, while max distance restricts the flight radius around the Home Point of the aircraft. These limits can be changed in the DJI Fly app for improved flight safety.

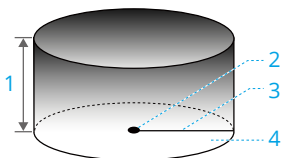

1. Max Altitude
2. Home Point (Horizontal Position)
3. Max Distance
4. Height of aircraft when taking off

*Strong GNSS Signal*

	Flight Restrictions	Prompt in DJI Fly App
Max Altitude	Altitude of the aircraft cannot exceed the value set in DJI Fly.	Max flight altitude reached.
Max Distance	The straight-line distance from the aircraft to the Home Point cannot exceed the max flight distance set in DJI Fly.	Max flight distance reached.

*Weak GNSS Signal*

	Flight Restrictions	Prompt in DJI Fly App
Max Altitude	<ul style="list-style-type: none"> <li>Altitude is restricted to 30 m from the takeoff point if lighting is sufficient.</li> <li>Altitude is restricted to 2 m above the ground if lighting is not sufficient and the downward infrared sensing system is functioning.</li> <li>Altitude is restricted to 30 m from the takeoff point if lighting is not sufficient and the downward infrared sensing system is not functioning.</li> </ul>	Max flight altitude reached.
Max Distance	No limit	

-  • Each time the aircraft is powered on, the altitude limit will be automatically removed as long as the GNSS signal becomes strong (GNSS signal strength  $\geq 2$ ), and the limit will not take effect even if the GNSS signal becomes weak afterwards.
- If the aircraft flies out of the set flight range due to inertia, you can still control the aircraft but cannot fly it any further away.

**GEO Zones**

The DJI GEO system designates safe flight locations, provides risk levels and safety notices for individual flights, and offers information on restricted airspace. All restricted flight areas are referred to as GEO Zones, which are further divided into Restricted Zones, Authorization Zones, Warning Zones, Enhanced Warning Zones, and Altitude

Zones. You can view such information in real-time in DJI Fly. GEO Zones are specific flight areas, including but not limited to airports, large event venues, locations where public emergencies have occurred (such as forest fires), nuclear power plants, prisons, government properties, and military facilities. By default, the GEO system limits takeoffs and flights in zones that may cause safety or security concerns. A GEO Zone map that contains comprehensive information on GEO Zones around the globe is available on the official DJI website: <https://fly-safe.dji.com/nfz/nfz-query>.

## Unlocking GEO Zones

**Self-Unlocking** is intended for unlocking Authorization Zones. To complete Self-Unlocking, you must submit an unlocking request via the DJI FlySafe website at <https://fly-safe.dji.com>. Once the unlocking request is approved, you can synchronize the unlocking license through the DJI Fly app. To unlock the zone, alternatively, you can launch or fly the aircraft directly into the approved Authorization Zone and follow the prompts in DJI Fly to unlock the zone.

**Custom Unlocking** is tailored for users with special requirements. It designates user-defined custom flight areas and provides flight permission documents specific to the needs of different users. This unlocking option is available in all countries and regions and can be requested via the DJI FlySafe website at <https://fly-safe.dji.com>.

- 
-  • To ensure flight safety, the aircraft will not be able to fly out of the unlocked zone after entering it. If the Home Point is outside the unlocked zone, the aircraft will not be able to return home.
- 

## 2.2 Flight Environment Requirements

1. DO NOT fly in severe weather conditions such as strong winds, snow, rain, and fog.
2. Only fly in open areas. Tall buildings and large metal structures may affect the accuracy of the onboard compass and GNSS system. After takeoff, make sure you are notified with the voice prompt that the Home Point is updated before continuing flight. If the aircraft has taken off near buildings, the accuracy of the Home Point cannot be guaranteed. In this case, pay close attention to the current position of the aircraft during auto RTH. When the aircraft is close to the Home Point, it is recommended to cancel auto RTH and manually control the aircraft to land at an appropriate location.
3. Fly the aircraft within visual line of sight (VLOS). Avoid mountains and trees blocking GNSS signals. Any flight beyond visual line of sight (BVLOS) can be conducted only when the aircraft performance, the knowledge and skills of the pilot, and the

operational safety management are compliant with local regulations for BVLOS. Avoid obstacles, crowds, trees, and bodies of water. For safety reasons, DO NOT fly the aircraft near airports, highways, railway stations, railway lines, city centers, or other sensitive areas, unless any permit or approval is obtained under local regulations.

4. When the GNSS signal is weak, fly the aircraft in environments with good lighting and visibility. The vision system may not work properly in poor light conditions.
5. Minimize interference by avoiding areas with high levels of electromagnetism, such as locations near power lines, base stations, electrical substations, and broadcasting towers.
6. The performance of the aircraft and its battery is limited when flying at high altitudes. Fly with caution. DO NOT fly above the specified altitude.
7. The braking distance of the aircraft is affected by the flight altitude. The higher the altitude, the greater the braking distance. When flying at high altitudes, you should reserve adequate braking distance to ensure flight safety.
8. GNSS cannot be used on the aircraft in polar regions. Use the vision system instead.
9. DO NOT take off from moving objects such as cars, ships, and airplanes.
10. DO NOT take off from solid-colored surfaces or surfaces with strong reflections such as a car roof.
11. Be careful when taking off in the desert or from a beach to avoid sand entering the aircraft.
12. DO NOT operate the aircraft in an environment at risk of a fire or explosion.
13. Use the aircraft and related devices in dry environments.
14. DO NOT use the aircraft and related devices in the following environments: accident scenes, fires, explosions, floods, tsunamis, avalanches, landslides, earthquakes, areas with dust or sandstorms. During operation, be sure to avoid exposure to salt spray and mold.
15. DO NOT operate the aircraft near bird flocks.

## 2.3 Operating the Aircraft Responsibly

To avoid serious injury and property damage, observe the following rules:

1. Make sure you are NOT under the influence of anesthesia, alcohol, or drugs or suffering from dizziness, fatigue, nausea, or other conditions that could impair the ability to operate the aircraft safely.
2. After landing, power off the aircraft first, then switch off the remote controller.

3. DO NOT drop, launch, fire, or otherwise project any dangerous payloads on or at any buildings, persons, or animals, which could cause personal injury or property damage.
4. DO NOT use an aircraft that has been accidentally damaged, crashed, or is not in good condition.
5. Make sure to train sufficiently and have contingency plans for emergencies or if an incident occurs.
6. Make sure to have a flight plan. DO NOT fly the aircraft recklessly.
7. Respect the privacy of others when using the camera. Make sure to comply with local privacy laws, regulations, and moral standards.
8. DO NOT use this product for any reason other than general personal use.
9. DO NOT use it for illegal or inappropriate purposes such as spying, military operations, or unauthorized investigations.
10. DO NOT use this product to defame, abuse, harass, stalk, threaten, or otherwise violate legal rights such as the right to privacy and publicity of others.
11. DO NOT trespass onto the private property of others.

## 2.4 Pre-Flight Checklist

1. Remove the gimbal cover from the camera.
2. Make sure the Intelligent Flight Battery and the propellers are mounted securely.
3. Make sure the remote controller, mobile device, and Intelligent Flight Battery are fully charged.
4. Make sure the aircraft arms and propellers are unfolded.
5. Make sure the gimbal and camera are functioning normally.
6. Make sure that there is nothing obstructing the motors and that they are functioning normally.
7. Make sure that DJI Fly is successfully connected to the aircraft.
8. Make sure all camera lenses and sensors are clean.
9. DO NOT install uncertified accessories or external devices, as this may result in product damage or safety hazards.



- To avoid diminished propulsion when the propeller guard is installed, do not use the DJI Lito Series Intelligent Flight Battery Plus or attach any third-party payloads.
-

10. Make sure the obstacle avoidance action is set in DJI Fly, and the **Max Altitude**, **Max Distance** and **Auto RTH Altitude** are all set properly according to local laws and regulations.

# Basic Flight

---



## 3 Basic Flight

### 3.1 Auto Takeoff/Landing

#### Auto Takeoff

1. Launch DJI Fly and enter the camera view.
2. Complete all steps in the pre-flight checklist.
3. Tap . If conditions are safe for takeoff, press and hold the button to confirm.
4. The aircraft will take off and hover above the ground.

#### Auto Landing

1. If conditions are safe to land, tap , then tap and hold  to confirm.
2. Auto landing can be canceled by tapping .
3. If the Downward Vision System is working normally, Landing Protection will be enabled.
4. Motors will stop automatically after landing.

---

 • Choose an appropriate place for landing.

---

### 3.2 Starting/Stopping the Motors

#### Starting the Motors

Perform one of the Combination Stick Commands (CSC) as shown below to start the motors. Once the motors have started spinning, release both sticks simultaneously.



#### Stopping the Motors

The motors can be stopped in two ways:

**Method 1:** When the aircraft has landed, push the throttle stick down and hold until the motors stop.

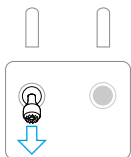

*Control Stick Mode: Mode 2*

**Method 2:** When the aircraft has landed, perform one of the CSC as shown below until the motors stop.



## Stopping the Motors Mid-Flight

---

 • Stopping the motors mid-flight will cause the aircraft to crash.

---

The default setting for **Emergency Propeller Stop** in the DJI Fly app is **Emergency Only**, which means that the motors can only be stopped mid-flight when the aircraft detects that it is in an emergency situation such as the aircraft is involved in a collision, a motor has stalled, the aircraft is rolling in the air, or the aircraft is out of control and is ascending or descending very quickly. To stop the motors mid-flight, perform the same CSC that was used to start the motors. Note that you need to hold the control sticks for two seconds while performing the CSC to stop the motors. **Emergency Propeller Stop** can be changed to **Anytime** in the app. Use this option with caution.

## 3.3 Controlling the Aircraft

The control sticks of the remote controller can be used to control the aircraft movements. The control sticks can be operated in Mode 1, Mode 2, or Mode 3, as shown below.

The default control mode of the remote controller is Mode 2. In this manual, Mode 2 is used as an example to illustrate how to use the control sticks. The more the stick is pushed away from the center, the faster the aircraft moves.

## Mode 1

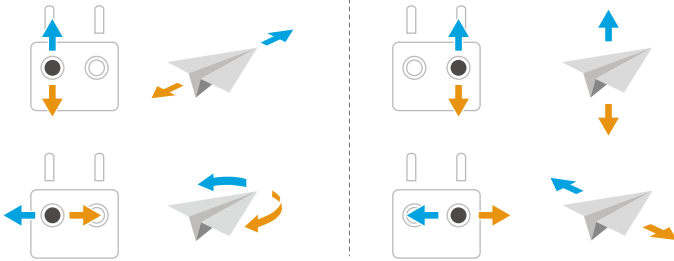

## Mode 2

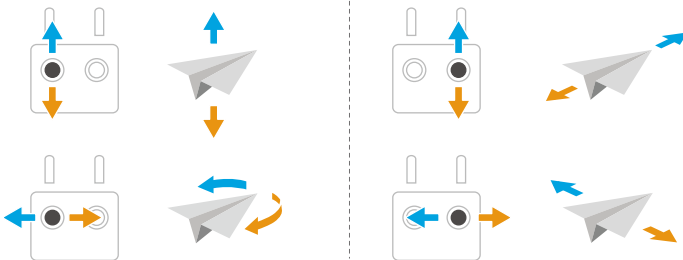

## Mode 3

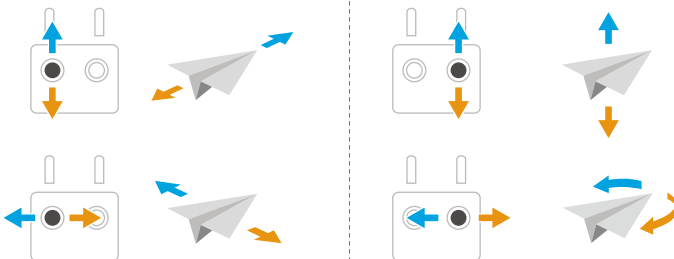

### 3.4 Takeoff/Landing Procedures

- ⚠ • DO NOT launch the aircraft from your palm or while holding it with your hand.
- DO NOT operate the aircraft when the lighting is too bright or too dark to use the remote controller. You are responsible for the correct adjustment of display brightness and amount of direct sunlight on the screen, as to avoid difficulty in viewing the screen clearly.

1. The pre-flight checklist is designed to help you fly safely. Go through the full pre-flight checklist before each flight.
2. Place the aircraft in an open, flat area with the rear of the aircraft facing towards you.
3. Power on the remote controller and the aircraft.
4. Launch DJI Fly and enter the camera view.
5. Wait for the aircraft self-diagnostics to complete. If DJI Fly does not show any irregular warning, you can start the motors.
6. Push the throttle stick up slowly to take off.
7. To land, hover over a level surface and push the throttle stick down to descend.
8. After landing, push the throttle down and hold until the motors stop.
9. Power off the aircraft before the remote controller.

### 3.5 Recording Audio via App

When the aircraft is used with the DJI RC-N3 remote controller, recording audio via the app is available. In the camera view of the app, tap **\*\*\* > Camera** to enable app recording. Audio will be recorded by the corresponding audio recording device while the aircraft is recording a video. The microphone icon will be displayed in liveview.



- DO NOT turn off the screen or switch to other apps during recording.



- Supported audio recording devices include the built-in microphone of the smartphone and Bluetooth devices. Audio recording compatibility issues may occur when using some Bluetooth devices. Make sure to test them before recording.
  - Audio recording can only be enabled or disabled before recording.
  - When viewing or downloading the videos in the Album view in DJI Fly, the audio recorded using the audio recording function will be automatically merged into the video file.
- 

### 3.6 Video Suggestions and Tips

1. Select the desired gimbal operation mode in DJI Fly.
2. It is recommended to take photos or record videos when flying in Normal or Cine mode.
3. DO NOT fly in bad weather such as on rainy or windy days.

4. Choose the camera settings that best suit your needs.
5. Perform flight tests to establish flight routes and preview scenes.
6. Push the control sticks gently to ensure smooth and stable movement of the aircraft.

# Intelligent Flight Mode

---

## 4 Intelligent Flight Modes



It is recommended to click the link below or scan the QR code to watch the tutorial video.



<https://www.dji.com/lito-x1/video>

### 4.1 FocusTrack

#### Spotlight

Enables the gimbal camera to face toward the subject all the time while you manually control the flight.

When the vision system is working normally, the aircraft will bypass or brake if an obstacle is detected, according to the obstacle avoidance action set in DJI Fly.

---

 Obstacle avoidance is disabled in Sport mode.

---

Supported Subjects:

- Stationary subjects
- Moving subjects (only vehicles, boats, and people)

#### Point of Interest (POI)

Allows the aircraft to fly around the subject.

The aircraft will bypass obstacles regardless of the flight modes or obstacle avoidance action settings in DJI Fly when the vision systems are working normally.



Supported Subjects:

- Stationary subjects
- Moving subjects (only vehicles, boats, and people)

#### ActiveTrack

The aircraft follows the subject.

Tap or slide the trace wheel to change tracking direction, and the aircraft will automatically fly from its current position  along the generated trajectory to the

selected tracking direction  and keep tracking. Users can also manually adjust the tracking direction, height, and distance using the control sticks. Tap the FocusTrack Settings icon  to set tracking parameters in the app.



The aircraft will bypass obstacles regardless of the flight modes or obstacle avoidance action settings in DJI Fly when the vision systems are working normally.

Supported Subjects:

Moving subjects (only vehicles, boats, and people).

In ActiveTrack, the supported distance and height ranges between the aircraft and subject are specified below.

Subject	People	Vehicles/Boats
Horizontal Distance	4-20 m	6-100 m
Height	0.5-15 m	6-100 m

-  The aircraft will fly to the supported distance and height range if the distance and height is out of range when ActiveTrack begins.
- It is recommended that the speed of the dynamic subject should not exceed 12 m/s; otherwise, the aircraft will not be able to track properly.

## Notice

---



-  The aircraft cannot avoid moving subjects such as people, animals, or vehicles. When using FocusTrack, pay attention to the surrounding environment to ensure flight safety.
- DO NOT use FocusTrack in areas with small or fine objects (e.g., tree branches or power lines), transparent objects (e.g., water or glass), or monochrome surfaces (e.g., white walls).

- Always be prepared to press the Flight Pause button on the remote controller or tap  in DJI Fly in order to operate the aircraft manually in case any emergency situation occurs.
- Be extra vigilant when using FocusTrack in any of the following situations:
  - ◆ The tracked subject is not moving on a level plane.
  - ◆ The tracked subject changes shape drastically while moving.
  - ◆ The tracked subject is out of sight for an extended period.
  - ◆ The tracked subject is in large monochrome areas such as snow-covered areas or deserts.
  - ◆ The tracked subject has a similar color or pattern to its surrounding environment.
  - ◆ The lighting is extremely dark (<5 lux) or bright (>100,000 lux).
- Make sure to follow local privacy laws and regulations when using FocusTrack.
- It is recommended to only track vehicles, boats, and people (but not children). Fly with caution when tracking other subjects.
- For the supported moving subjects, vehicles refer to cars and small to medium-sized boats. DO NOT track a remote controlled car or boat.
- The tracking subject may be inadvertently swapped to another subject if they pass nearby each other.

---

## Using FocusTrack

Before enabling FocusTrack, make sure the flying environment is open and unobstructed with sufficient light.

Tap the FocusTrack icon  on the left of the camera view, or select the subject on the screen to enable FocusTrack. After enabling, tap the FocusTrack icon  again to exit.



- During use, press the Flight Pause button on the remote controller to cancel the subject selection.
- 

## 4.2 MasterShots



The aircraft will select a preset flight route based on the subject type and distance, and automatically take a variety of classic aerial photography shots.

## Notice

---

- ⚠ • Use MasterShots at locations that are clear of buildings and other obstacles. Make sure there are no people, animals, or other obstacles in the flight path.
  - Always pay attention to obstacles around the aircraft and use the remote controller to avoid collisions or the aircraft being obstructed.
  - DO NOT use MasterShots in any of the following situations:
    - ◆ When the subject is blocked for an extended period of time or outside the visual line of sight.
    - ◆ When the subject is in large monochrome areas such as snow-covered areas or deserts.
    - ◆ When the subject is similar in color or pattern with the surroundings.
    - ◆ When the subject is in the air.
    - ◆ When the subject is moving fast.
    - ◆ The lighting is extremely dark (<5 lux) or bright (>100,000 lux).
  - DO NOT use MasterShots in places close to buildings or where the GNSS signal is weak. Otherwise, the flight path may become unstable.
  - Make sure to follow local privacy laws and regulations when using MasterShots.
- 

## Using MasterShots

1. Tap the Shooting Mode icon on the right side of the camera view and select MasterShots .
2. After drag-selecting the subject and adjusting the capturing area, tap  to begin recording and the aircraft will start flying and recording automatically. The aircraft will fly back to its original position once recording is finished.
3. Tap  or press the Flight Pause button on the remote controller once. The aircraft will exit MasterShots immediately and hover.

## 4.3 QuickShots

QuickShots include multiple capturing modes. The aircraft automatically records according to the selected capturing mode and generates a short video.



---

## Notice

---

-  • Make sure there is sufficient space when using Boomerang. Allow a radius of at least 30 m (99 ft) around the aircraft and a space of at least 10 m (33 ft) above the aircraft.
  - Make sure there is sufficient space when using Asteroid. Allow at least 40 m (131 ft) behind and 50 m (164 ft) above the aircraft.
  - Use QuickShots at locations that are clear of buildings and other obstacles. Make sure there are no people, animals, or other obstacles in the flight path.
  - Always pay attention to objects around the aircraft and use the remote controller to avoid collisions or the aircraft being obstructed.
  - DO NOT use QuickShots in any of the following situations:
    - ◆ When the subject is blocked for an extended period of time or outside the visual line of sight.
    - ◆ When the subject is in large monochrome areas such as snow-covered areas or deserts.
    - ◆ When the subject is similar in color or pattern with the surroundings.
    - ◆ When the subject is in the air.
    - ◆ When the subject is moving fast.
    - ◆ The lighting is extremely dark (<5 lux) or bright (>100,000 lux).
  - DO NOT use QuickShots in places close to buildings or where the GNSS signal is weak. Otherwise, the flight path will become unstable.
  - Make sure to follow local privacy laws and regulations when using QuickShots.
- 



## Using QuickShots

1. Tap the Shooting Mode icon on the right side of the camera view and select QuickShots .
2. After selecting one sub-mode, tap the plus icon or drag-select the subject on the screen. Then tap  to begin capturing. The aircraft will record footage while performing a preset flight movement according to the option selected, and generate a video afterwards. The aircraft will fly back to its original position once recording is finished.
3. Tap  or press the Flight Pause button on the remote controller once. The aircraft will exit QuickShots immediately and hover.

## 4.4 Hyperlapse

Hyperlapse takes a certain number of photos according to the time interval, and then compiles these photos into a video of a few seconds. It is especially suitable for recording scenes with moving elements, such as traffic flow, clouds drifting, and sunrises and sunsets.



### Using Hyperlapse

1. Tap the Shooting Modes icon from the camera view and select Hyperlapse .
2. Select the Hyperlapse mode. After setting the related parameters, tap the shutter/record button  to begin the process.
3. Tap  or press the Stop button on the remote controller, the aircraft will exit Hyperlapse and hover.

## 4.5 Waypoint Flight



With Waypoint Flight, you can set waypoints for different capturing locations in advance, and then generate a flight route based on the set waypoints. The aircraft will then fly automatically along the preset route and complete the preset camera actions.

The flight routes can be saved and repeated at different times to capture the changes over seasons and day-to-night effect.

- 
-  • Before enabling the Waypoint Flight mode, tap **\*\*\* > Safety > Manual Obstacle Avoidance** to check the obstacle avoidance action. After setting the obstacle avoidance action to **Bypass** or **Brake**, the aircraft will brake if it detects obstacles during the waypoint flight. If set to **Off**, the aircraft cannot avoid obstacles.
  - The flight route will curve between waypoints, so the aircraft altitude between waypoints may become lower than the altitudes of the waypoints during the flight. Make sure to avoid any obstacles below when setting a waypoint.
- 
-  • Before takeoff, you can only use the map to add waypoints.
  - Connect the remote controller to the internet and download the map before using the map to add a waypoint.
  - If **Camera Action** is set to **None**, the aircraft will only automatically fly. You need to manually control the camera during the flight.
  - If you have already set **Heading** and **Gimbal Tilt** to **Face POI**, then the POI will automatically be linked to these waypoints.

- When using Waypoint Flight in the EU, the action for **On Signal Lost** cannot be set to **Continue**.

## Using Waypoint Flight

1. Tap  on the left of the camera view to enable Waypoint Flight.
2. Follow the on-screen instructions to complete the settings and perform the flight route.
3. Tap  again to exit waypoint flight and the flight route will be saved to the Library automatically.

## 4.6 Cruise Control

Cruise Control enables the flight speed to be locked, making control easier and camera movements smoother. While cruising, you can apply additional control stick input to achieve dynamic camera movements, such as spiraling up..

-  • The obstacle avoidance in cruise control follows the current flight mode. Fly with caution.

## Using Cruise Control

1. Set one customizable button of the remote controller to Cruise Control.
2. When pushing the control sticks, press the cruise control button, and the aircraft will automatically fly at the current speed.
3. Press Flight Pause button on the remote controller once, or tap  to exit cruise control.

# Aircraft

---

## 5 Aircraft

### 5.1 Flight Mode

The aircraft supports the following flight modes, which can be switched via the Flight Mode switch on the remote controller.

**Normal Mode:** Normal mode is suitable for most flight scenarios. The aircraft can hover precisely, fly stably, and use Intelligent Flight Modes.

**Sport Mode:** The maximum horizontal flight speed of the aircraft will be higher when compared with Normal mode. Note that obstacle avoidance is disabled in Sport mode.

**Cine Mode:** Cine mode is based on Normal mode with a limited flight speed, making the aircraft more stable during recording.

The aircraft automatically changes to Attitude (ATTI) mode when the vision system is unavailable or disabled and the GNSS signal is weak or the compass experiences interference. In ATTI mode, the aircraft may be more easily affected by its surroundings. Environmental factors such as wind can result in horizontal drift of the aircraft, which may present hazards, especially when flying in confined spaces. The aircraft will not be able to hover or brake automatically, therefore the pilot should land the aircraft as soon as possible to avoid accidents.



- The flight modes are only effective for manual flight and cruise control.



- The vision system is disabled in Sport mode, which means the aircraft cannot sense obstacles on its route automatically. You must stay alert to the surrounding environment and control the aircraft to avoid obstacles.
  - The maximum speed and braking distance of the aircraft significantly increase in Sport mode. A minimum braking distance of 40 m is required in windless conditions.
  - A minimum braking distance of 15 m is required in windless conditions while the aircraft is ascending and descending in Sport mode or Normal mode.
  - The responsiveness of the aircraft significantly increases in Sport mode, which means a small control stick movement on the remote controller translates into the aircraft moving a large distance. Make sure to maintain adequate maneuvering space during flight.
  - You may experience shaking in videos recorded in Sport mode.
-

## 5.2 Aircraft Status Indicators



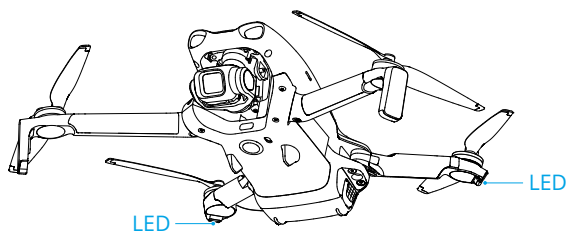

The aircraft has two aircraft status indicators.







When the aircraft is powered on, but the motors are not running, the aircraft status indicators will display the current status of the aircraft.

### Aircraft Status Indicators Descriptions

#### Normal States

 .....	Blinks red, yellow, and green alternately	Powering on and performing self-diagnostic tests
 × 4 .....	Blinks yellow four times	Warming up
 .....	Blinks green slowly	GNSS enabled
 × 2 .....	Blinks green twice repeatedly	Vision systems enabled
 .....	Blinks yellow slowly	GNSS and vision system disabled (ATTI mode enabled)

#### Warning States

 .....	Blinks yellow quickly	Remote controller signal lost
 .....	Blinks red slowly	Takeoff is disabled (e.g., low battery) <sup>[1]</sup>
 .....	Blinks red quickly	Critically low battery
 —	Solid red	Critical error
 .....	Blinks red and yellow alternately	Compass calibration required

[1] If the aircraft cannot take off while the status indicators are blinking red slowly, view the warning prompt in DJI Fly.

After the motors start, the aircraft status indicators will blink green. While in Chinese Mainland, the status indicator on the left side of the aircraft blinks red and the status indicator on the right side blinks green.

- 
- ⚠ • Lighting requirements vary depending on the region. Observe local laws and regulations.
- 

## 5.3 Return to Home

Carefully read the contents of this section to ensure you are familiar with the behavior of the aircraft in Return-to-Home (RTH).

The Return to Home (RTH) function will automatically fly the aircraft back to the last recorded Home Point. RTH can be triggered in three ways: the user actively triggers RTH, the aircraft has low battery, or the remote controller signal has been lost (Failsafe RTH is triggered). If the aircraft has recorded the Home Point successfully and the positioning system is functioning normally, when the RTH function is triggered, the aircraft will automatically fly back and land at the Home Point.

- 
- 📖 • **Home Point:** The Home Point will be recorded at takeoff as long as the aircraft has a strong GNSS signal  26 or the lighting is sufficient. After the Home Point is recorded, DJI Fly will issue a voice prompt. If it is necessary to update the Home Point during a flight (such as if you have changed your position), the Home Point can be manually updated in \*\*\* > **Safety** page in DJI Fly. When the aircraft is used with the DJI RC 2 remote controller, [Dynamic Home Point](#) is available.
- 

During RTH, the AR RTH route will be displayed on the camera view, helping you to view the return path and ensure flight safety. The camera view also displays the AR Home Point. When the aircraft reaches the area above the Home Point, the gimbal camera will automatically flip downwards. The AR aircraft shadow will appear in the camera view when the aircraft is approaching the ground, enabling you to control the aircraft to land more accurately in your preferred location.

The AR Home Point, AR RTH route, and AR aircraft shadow will be displayed in the camera view by default. The display can be changed in \*\*\* > **Safety** > **AR Settings**.

- 
- ⚠ • The AR RTH route is only used for reference, and may deviate from the actual flight route in different scenarios. Always pay attention to the liveview on the screen during RTH. Fly with caution.
  - During RTH, the aircraft will automatically adjust the gimbal tilt to point the camera toward the RTH route by default. Using the gimbal dial to adjust

the camera orientation or pressing the customizable buttons on the remote controller to recenter the camera will stop the aircraft from automatically adjusting the gimbal tilt, which may prevent the AR RTH route from being viewed.

---

## Notice

---

- ⚠ • The aircraft may not be able to return to the Home Point as normal if the positioning system is functioning abnormally. During Failsafe RTH, the aircraft may enter ATTI mode and land automatically if the positioning system is functioning abnormally.
- When there is no GNSS, do not fly over water surfaces, buildings with glass surface, or in scenarios where the altitude above the ground is greater than 30 meters. If the positioning system is functioning abnormally, the aircraft will enter ATTI mode.
- It is important to set a suitable RTH altitude before each flight. Launch DJI Fly and set the RTH altitude.
- The aircraft cannot sense obstacles during RTH if the environment conditions are not suitable for the sensing system.
- GEO zones may affect the RTH. Avoid flying near GEO zones.
- The aircraft may not be able to return to a Home Point if the wind speed is too high. Fly with caution.
- Pay extra attention to small or fine objects (such as tree branches or power lines) or transparent objects (such as water or glass) during RTH. Exit RTH and control the aircraft manually in an emergency.
- Set Advanced RTH as **Preset** if there are power lines or transmission towers that the aircraft cannot bypass on the RTH path and make sure the RTH Altitude is set higher than all obstacles.
- The aircraft will brake and return to home according to the latest settings if the **Advanced RTH** settings in DJI Fly are changed during RTH.
- If the max altitude is adjusted below the current altitude during RTH, the aircraft will descend to the max altitude first and then continue returning to home.
- The RTH Altitude cannot be changed during RTH.
- If there is a large difference between the current altitude and the RTH altitude, the amount of battery power used cannot be calculated accurately due to wind speed differences at different altitudes. Pay extra attention to the battery power prompts and warning prompts in DJI Fly.

- When the remote controller signal is normal during Advanced RTH, the pitch stick can be used to control the flight speed, but the orientation and altitude cannot be controlled and the aircraft cannot be controlled to fly to the left or right. Constantly pushing the pitch stick to accelerate will increase the battery power consumption speed. The aircraft cannot bypass obstacles if the flight speed exceeds the effective sensing speed. The aircraft will brake and hover in place and exit RTH if the pitch stick is pushed all the way down. The aircraft can be controlled after the pitch stick is released.
  - If the aircraft reaches the altitude limit of the aircraft current location or of the Home Point while it is ascending during Preset RTH, the aircraft stops ascending and returns to the Home Point at the current altitude. Pay attention to flight safety during RTH.
  - If the Home Point is within the Altitude Zone but the aircraft is not in the Altitude Zone, when the aircraft reaches the Altitude Zone it will descend below the altitude limit, which may be lower than the set RTH altitude. Fly with caution.
  - The aircraft will exit RTH if the surrounding environment is too complex to complete RTH, even if the sensing system is working properly.
  - RTH cannot be triggered during auto landing.
- 

## Advanced RTH

When Advanced RTH is triggered, the aircraft will automatically plan the best RTH path, which will be displayed in DJI Fly and will be adjusted according to the environment. During RTH, the aircraft will adjust the flight speed automatically according to environmental factors such as the wind speed, wind direction, and obstacles.

If the control signal between the remote controller and the aircraft is good, exit RTH by tapping  in DJI Fly or by pressing the RTH button on the remote controller. After exiting RTH, you will regain control of the aircraft.

## Trigger Method

### The user actively triggers RTH

During flight, you can trigger RTH by pressing and holding the RTH button on the remote controller, or tapping  from the left side of the camera view and then pressing and holding the RTH icon.

If the remote controller signal is lost during RTH, the aircraft will continue the RTH procedure regardless of the preset Signal Lost Action.

## Aircraft low battery

During flight, if the battery level is low and only sufficient to fly to the Home Point, a warning prompt will appear in DJI Fly. If you tap to confirm RTH or do not take action before the countdown ends, the aircraft will automatically initiate low battery RTH.

If you cancel the low battery RTH prompt and continue flying the aircraft, the aircraft will land automatically when the current battery level can only support the aircraft long enough to descend from its current altitude.

Auto landing cannot be cancelled but you can still fly the aircraft horizontally by moving the pitch stick and roll stick, and change the descent speed of the aircraft by moving the throttle stick. Fly the aircraft to a suitable place for landing as soon as possible.



- When the Intelligent Flight Battery level is too low and there is not enough power to return home, land the aircraft as soon as possible. Delayed action will initiate progressive thrust decay, potentially escalating to uncontrolled descent upon total depletion. This may cause aircraft destruction, third-party property damage, or personal injury.
  - DO NOT keep pushing the throttle stick upward during auto landing. Otherwise, the aircraft will experience progressive thrust decay and even crash after the battery power is completely depleted.
- 

## Loss of remote controller signal

When the remote controller signal is lost for more than 6 seconds, the aircraft will automatically initiate Failsafe RTH if the Signal Lost Action is set to RTH. The action can also be set to Hover or Landing.

When the lighting and environment conditions are suitable for the vision system, DJI Fly will display the RTH path that was generated by the aircraft before the signal was lost. The aircraft will start RTH using Advanced RTH according to the RTH settings. The aircraft will remain in RTH even if the remote controller signal is restored. DJI Fly will update the RTH path accordingly.

When the lighting and environment conditions are unsuitable for the vision system, the aircraft will brake and hover, then enter Original Route RTH.

- If the RTH distance (the horizontal distance between the aircraft and the Home Point) is farther than 50 m, the aircraft adjusts its orientation and flies backward for 50 m on its original flight route before entering Preset RTH.
- If the RTH distance is farther than 5 m but less than 50 m, the aircraft adjusts its orientation and flies straight horizontally back to the home point at the current altitude.
- The aircraft lands immediately if the RTH distance is less than 5 m.

## RTH Procedure

After Advanced RTH is triggered, the aircraft brakes and hovers in place.

- **When the environment or lighting conditions are suitable for the vision system:**
  - ♦ The aircraft will adjust its orientation to the Home Point, plan the best path according to the RTH settings and then return to the Home Point if GNSS is available at takeoff.
  - ♦ If GNSS was unavailable and only the vision system was working when takeoff, the aircraft will adjust its orientation to the Home Point, plan the best path according to the RTH settings and then return to the position with strong GNSS signal based on the RTH settings. It will approximately follow the outbound trajectory back to the vicinity of the home point. At this time, pay attention to the app prompts and choose whether to let the aircraft automatically RTH and land or to manually control the RTH and landing.

### **Pay attention if GNSS was unavailable when takeoff:**

- ◊ Make sure that the obstacle avoidance is enabled.
- ◊ DO NOT fly in narrow spaces and the environmental wind speed should be less than 3 m/s.
- ◊ Fly to the open area and stay at least 10 meters away from any obstacles quickly after takeoff, otherwise, the aircraft may not be able to return to home. During flight, avoid flying over water surfaces until reaching an area with strong GNSS signal. The altitude above the ground should be greater than 2 meters and less than 30 meters, otherwise, the aircraft may not be able to return to the home point. If the aircraft enters ATTI mode before reaching the area with strong GNSS signal, the home point will be invalidated.
- ◊ If the vision positioning is not available during flight, the aircraft cannot return to the home point. Pay attention to the environment according to the App voice prompts to prevent collisions.
- ◊ When the aircraft returns to the vicinity of the takeoff point and the App prompts when the current environment is complex, please confirm whether to continue flying:
  - You need to confirm whether the flight path is correct and pay attention to flight safety.
  - You need to confirm whether the lighting condition is sufficient for the vision system. If not, the aircraft may exit RTH. Forcing the aircraft to continue RTH or flight may cause it to enter ATTI mode.

- ◊ After confirmation, the aircraft will continue to return to the home point at a low speed. If an obstacle appears on the return path, the aircraft will brake and may exit RTH.
  - ◊ This RTH process does not support dynamic obstacle detection (including pedestrians, etc.) and does not support obstacle detection in textureless scenes such as glass or white walls.
  - ◊ This RTH process requires the ground and nearby environments (such as walls) to have rich textures and no dynamic changes.
- **When the environment or lighting conditions are not suitable for the vision system:**
    - If the RTH distance is farther than 5 meters, the aircraft will return to home according to the **Preset**.
    - The aircraft lands immediately if the RTH distance is less than 5 m.

## RTH Settings

RTH settings are available for Advanced RTH. Go to the camera view in DJI Fly, tap **\*\*\*> Safety**, and scroll to **Return to Home (RTH)**.

- **Optimal:**



- If the lighting is sufficient and the environment is suitable for the vision system, the aircraft will automatically plan the optimal RTH path and adjust the altitude according to environmental factors, such as obstacles and transmission signals, regardless of the RTH Altitude setting. The optimal RTH path means the aircraft will travel the shortest distance possible to reduce the amount of battery power used and to increase flight time.
  - If the lighting is insufficient or the environment is not suitable for the vision system, the aircraft will perform Preset RTH based on the RTH Altitude setting.
- **Preset:**

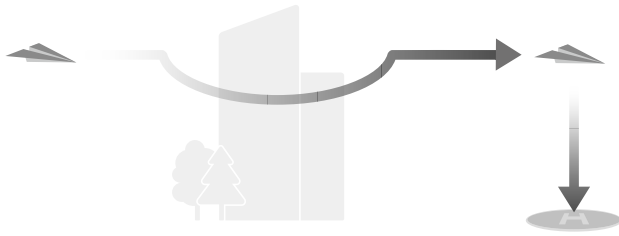

RTH Distance/Altitude		Suitable Lighting and Environment Conditions	Unsuitable Lighting and Environment Conditions
RTH distance > 50 m	Current altitude < RTH altitude	The aircraft will plan the RTH path, fly to an open area while bypassing obstacles, ascend to the RTH Altitude, and return to home using the best path.	The aircraft will ascend to the RTH altitude, and fly to the Home Point in a straight line at the RTH altitude. <sup>[1]</sup>
	Current altitude ≥ RTH altitude	The aircraft will return to home using the best path at the current altitude.	The aircraft will fly to the Home Point in a straight line at the current altitude. <sup>[1]</sup>
RTH distance is within 5-50 m			The aircraft will fly to the Home Point in a straight line at the current altitude. <sup>[2]</sup>

[1] If the forward-facing LiDAR detects an obstacle ahead, the aircraft will ascend to avoid the obstacle. It will stop climbing once the path ahead is clear and then continue to RTH. If the obstacle height exceeds the altitude limit, the aircraft will brake and hover, and the user will need to take control.

[2] If the forward-facing LiDAR detects an obstacle ahead, the aircraft will brake and hover, and the user will need to take control.

When the aircraft is approaching the Home Point, if the current altitude is higher than the RTH altitude, the aircraft will intelligently decide whether to descend while flying forward according to the surrounding environment, lighting, the set RTH altitude, and the current altitude. When the aircraft reaches the area above the Home Point, the current altitude of the aircraft will not be lower than the set RTH altitude.

The RTH plans for different environments, RTH trigger methods, and RTH settings are as follows:

RTH Trigger Method	Suitable Lighting and Environment Conditions (The aircraft can bypass obstacles and GEO zones)	Unsuitable Lighting and Environment Conditions
The user actively triggers RTH	The aircraft will execute RTH based on the RTH setting: <ul style="list-style-type: none"> <li>• Optimal</li> <li>• Preset</li> </ul>	Preset (The aircraft can ascend to bypass obstacles and GEO zones)
Aircraft low battery		Original route RTH, Preset RTH will be executed when the signal is restored (The aircraft can bypass GEO zones and will brake and hover if there is obstacle)
Loss of remote controller signal		

## Landing Protection

During RTH, landing protection activates once the aircraft begins to land.

The specific performance of the aircraft is as follows:

- If the ground is determined suitable for landing, the aircraft will land directly.
- If the ground is determined unsuitable for landing, the aircraft will hover and wait for pilot confirmation.
- If landing protection is not operational, DJI Fly will display a landing prompt when the aircraft descends to 0.5 m from the ground. Tap **Confirm** or push the throttle stick all the way down and hold for one second, and the aircraft will land.



- Landing Protection only assists in determining the landing environment. Pay attention to the surrounding environment during landing to ensure safety.
- In the following situations, Landing Protection may be unavailable and the aircraft may land directly:
  - Flying over monochrome, reflective, or low-light surfaces, a large area of surfaces without clear texture, or surfaces with dynamic texture, such as smooth ceramic tiles, garage floors with insufficient light, and grass blowing in the wind.
  - Flying over obstacles without clear texture, such as large rocks, or reflective or monochrome surfaces, such as raised tiles.
  - Flying over small or fine obstacles, such as power lines and tree branches.
  - Flying over surfaces that resemble flat ground, such as trimmed and flat shrubs, flat tree tops, and hemispherical ground.

- In the following situations, Landing Protection may be falsely triggered and the aircraft is unable to land:
  - ♦ Flying over surfaces that the vision system may confuse for water, such as wet ground and areas with puddles.
  - ♦ Flying over flat surfaces, but there are surfaces with clear texture (oblique surfaces or stairs) nearby.



- After reaching the area above the Home Point, the aircraft will land precisely on the takeoff point. Performing a precision landing is subject to the following conditions:
    - ♦ The Home Point must be recorded upon takeoff and must not be changed during flight.
    - ♦ During takeoff, the aircraft must vertically ascend at least 7 m before moving horizontally.
    - ♦ The Home Point terrain features must remain largely unchanged.
    - ♦ The terrain features of the Home Point must be sufficiently distinctive. Terrain such as a snow-covered field is not suitable.
    - ♦ The lighting conditions must not be too bright or too dark.
  - During landing, movement of any other control stick apart from the throttle stick will be regarded as giving up precision landing, and the aircraft will descend vertically.
- 

## Dynamic Home Point

When the aircraft is used with the DJI RC 2 remote controller, Dynamic Home Point is available.

When the GNSS signal of the remote controller is strong, enable Dynamic Home Point through any of the following methods, and the Home Point will be continuously updated to the remote controller location.

- In camera view, tap  > **Update Home Point > Dynamic Home Point > Update.**
- In camera view, tap \*\*\* > **Safety > Update Home Point > Dynamic Home Point > Update.**

When Dynamic Home Point is enabled, the RTH icon will turn blue. After RTH is triggered, the aircraft will return near the Home Point, exit RTH, and hover. Users can control the aircraft.



- After enabling Dynamic Home Point for the first time, if the GNSS signal of the remote controller is weak, the dynamic Home Point may not be available.

- Use the Dynamic Home Point function in an open environment with a strong GNSS signal. Otherwise, the Home Point will have a large deviation from the actual remote controller location.
  - Once the dynamic Home Point is available, if the GNSS signal of the remote controller is weak, the Home Point will remain at the last successfully updated location. When RTH is triggered, check if the Home Point location is the latest remote controller location.
- 

## 5.4 Sensing System

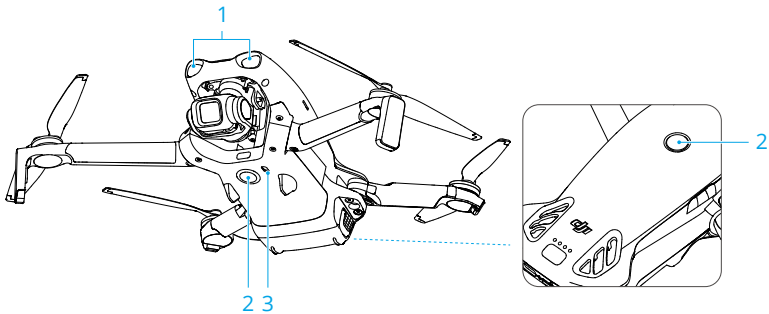

1. Forward-Facing LiDAR
2. Omnidirectional Monocular Vision System
3. Downward Infrared Sensing System

The forward-facing LiDAR can detect obstacles ahead. The omnidirectional monocular vision system works best with adequate lighting and clearly marked or textured obstacles. The omnidirectional monocular vision system will activate automatically when the aircraft is in Normal or Cine mode and obstacle avoidance action is set to **Bypass** or **Brake** in DJI Fly. The positioning function is applicable when GNSS signals are unavailable or weak.



- When Vision Positioning and Obstacle Avoidance is disabled, the aircraft relies only on GNSS to hover, omnidirectional obstacle avoidance is unavailable, and the aircraft will not automatically decelerate during descent close to the ground. Extra caution is required when Vision Positioning and Obstacle Avoidance is disabled.
- Disabling Vision Positioning and Obstacle Avoidance takes effect only when flying manually, and will not take effect when using RTH, auto landing, or using Intelligent Flight Modes.

- Vision Positioning and Obstacle Avoidance can be temporarily disabled in clouds and fog or when an obstacle is detected when landing. Keep Vision Positioning and Obstacle Avoidance enabled in regular flight scenarios. Vision Positioning and Obstacle Avoidance is enabled by default after restarting the aircraft.

---

## Notice



- Pay attention to the flight environment. The sensing system only works in certain scenarios and cannot replace human control and judgment. During a flight, always pay attention to the surrounding environment and the warnings in DJI Fly, and be responsible for and maintain control of the aircraft at all times.
- If there is no GNSS available, the downward vision system will assist with aircraft positioning, and works best when the aircraft is at an altitude from 0.5 m to 30 m. Extra caution is required if the altitude of the aircraft is above 30 m as the vision positioning performance may be affected.
- The downward vision system may not work properly when the aircraft is flying near water. Therefore, the aircraft may not be able to actively avoid water below it when landing. It is recommended to maintain flight control at all times, make reasonable judgments based on the surrounding environment, and avoid over-relying on the downward vision system.
- The vision system cannot accurately identify large structures with frames and cables, such as tower cranes, high-voltage transmission towers, high-voltage transmission lines, cable-stayed bridges, and suspension bridges.
- The vision system cannot work properly near surfaces without clear pattern variations or where the lighting is too weak or too strong. The vision system cannot work properly in the following situations:
  - ♦ Flying near monochrome surfaces (e.g., pure black, white, red, or green).
  - ♦ Flying near highly reflective surfaces.
  - ♦ Flying near water or transparent surfaces.
  - ♦ Flying near moving surfaces or objects.
  - ♦ Flying in an area with frequent and drastic lighting changes.
  - ♦ Flying near extremely dark (<1 lux) or bright (>100,000 lux) surfaces.
  - ♦ Flying near surfaces that strongly reflect or absorb infrared waves (e.g., mirrors, glass, road signs, and asphalt pavements).
  - ♦ Flying near surfaces without clear patterns or textures.
  - ♦ Flying near surfaces with repeating identical patterns or textures (e.g., tiles with the same design).

- Flying near obstacles with small surface areas (e.g., tree branches, and power lines).
  - Flying near small pole-like objects (e.g., utility poles, streetlight poles).
  - Flying near moving subjects (e.g., people walking or vehicles).
  - Keep the sensors clean at all times. DO NOT scratch or tamper with the sensors. DO NOT use the aircraft in dusty or humid environments.
  - The vision system cameras may need to be calibrated after being stored for an extended period. A prompt will appear in DJI Fly and calibration will be performed automatically.
  - DO NOT fly when it is rainy, smoggy, or the visibility is lower than 100 m.
  - DO NOT obstruct the sensing system.
  - DO NOT take off rapidly towards an obstacle to avoid the risk of the sensing system failing to respond in time, which could lead to a collision.
  - Check the following each time before takeoff:
    - Make sure there are no stickers or any other obstructions over the glass of the sensing system.
    - Use a soft cloth if there is any dirt, dust, or water on the glass of the sensing system. DO NOT use any cleaning product that contains alcohol.
    - Contact DJI Support if there is any damage to the lenses of the sensing system.
  - The aircraft can fly at any time of the day or night. However, the vision system becomes unavailable when flying the aircraft at night. Fly with caution.
  - The forward-facing LiDAR cannot detect obstacles with a reflectivity of less than 10% or reflective objects such as glass.
  - The forward-facing LiDAR cannot work properly in environments with too strong lighting (>40,000 lux).
- 

## 5.5 Advanced Pilot Assistance Systems

The Advanced Pilot Assistance Systems (APAS) feature is available in Normal mode and Cine mode. When APAS is enabled, the aircraft will continue to respond to your commands and plan its path according to both control stick inputs and the flight environment. APAS makes it easier to avoid obstacles, obtain smoother footage, and give a better flying experience.

When APAS is enabled, the aircraft can be stopped by pressing the Flight Pause button on the remote controller. The aircraft brakes and hovers for three seconds and awaits further pilot commands.

To enable APAS, open DJI Fly, go to **\*\*\* > Safety > Manual Obstacle Avoidance**, and select **Bypass**. Set **Bypassing Options** to **Normal** or **Nifty**. In **Nifty** mode, the aircraft can fly faster, smoother, and closer to obstacles obtaining better footage while bypassing obstacles. However, the risk of crashing into obstacles will increase. Fly with caution.

**Nifty** mode cannot work normally in the following situations:

- When aircraft orientation changes rapidly flying near obstacles.
- When flying through narrow obstacles such as canopies or bushes at high speed.
- When flying near obstacles that are too small to detect.
- When flying with the propeller guard.

## Notice

---



- Make sure to use APAS when the vision system is available. Make sure there are no people, animals, objects with small surface areas (e.g., tree branches), or transparent objects (e.g., glass or water) along the desired flight path.
  - Make sure to use APAS when the downward vision system is available or the GNSS signal is strong. APAS may not function properly when the aircraft is flying over water or snow-covered areas.
  - Be extra cautious when flying in extremely dark (<5 lux) or bright (>100,000 lux) environments.
  - Pay attention to DJI Fly and make sure APAS is working normally.
  - APAS may not function properly when the aircraft is flying near flight limits or in a GEO zone.
  - When the lighting becomes insufficient and the vision system is partially unavailable, the aircraft will switch from bypassing obstacles to braking and hovering. You need to center the control stick and then to continue controlling the aircraft.
- 

## Landing Protection

If obstacle avoidance action is set to **Bypass** or **Brake**, Landing Protection will be activated when you push the throttle stick down to land the aircraft. Landing Protection is enabled once the aircraft begins to land.

- If the ground is determined to be suitable for landing, the aircraft will land directly.

- If the ground is determined to be unsuitable for landing, the aircraft will hover when the aircraft descends to a certain height above ground. Push down on the throttle stick for at least five seconds, and the aircraft will land without obstacle avoidance.

## 5.6 Vision Assist

To help users navigate and observe obstacles during flight, the vision assist view automatically switches to the corresponding vision sensor feeds based on the flight direction.

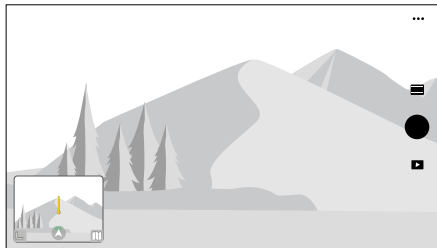

Swipe left on the attitude indicator, right on the mini map, or tap the icon in the lower right corner of the attitude indicator to switch to the vision assist view. Tap the center of the screen to maximize the vision assist view.

- 
- ⚠ • When using vision assist, the quality of the video transmission may be lower due to transmission bandwidth limits, cell phone performance, or the video transmission resolution of the screen on the remote controller.
  - It is normal for components of the aircraft to appear in the vision assist view.
  - Vision assist should be used for reference only. Glass walls and small objects such as tree branches, electric wires, and kite strings cannot be displayed accurately.
  - Vision assist is not available when the aircraft has not taken off or when the video transmission signal is weak.
-

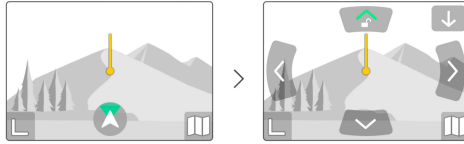

1. Tap the view direction icon .
2. Tap the arrow to switch between different directions of the vision assist view. Tap the direction again to lock the direction.

The direction of the line indicates the current flight speed direction of the aircraft, and the length of the line indicates the flight speed of the aircraft.

- 
-  When the direction is not locked in a specific direction, the vision assist view automatically switches to the current flight direction. Tap any other directional arrow to switch the direction of the vision assist view for a while before returning to the view of the current flight direction.
- 

### Collision Warning

When an obstacle in the current view direction is detected, the vision assist view shows a collision warning. The color of the warning is determined by the distance between the obstacle and the aircraft. Yellow and red colors indicate the relative distance ranging from far to near.

- 
-  The FOV of the vision assist in all directions is limited. It is normal not to see obstacles in the field of view during a collision warning.
  - The collision warning is not controlled by the **Display Radar Map** switch and remains visible even when the radar map is switched off.
  - A collision warning appears only when the vision assist view is displayed in the small window.
- 

## 5.7 Propellers

### Attaching/Detaching the Propellers

Attach the marked propellers to the motors of the marked arm, and the unmarked propellers to the motors of the unmarked arm. Use the screwdriver from the aircraft package to mount and remove the propellers. Make sure the screws are properly tightened when mounting the propellers.

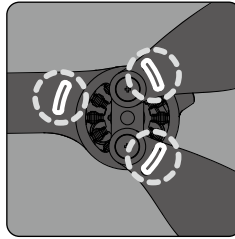
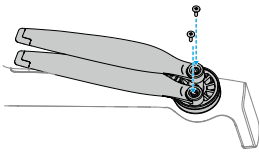

Marked

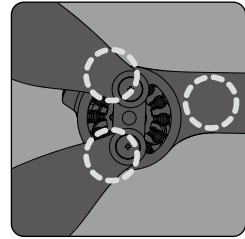

Unmarked

---

## Notice

- ⚠ • The propeller blades are sharp. Handle with care to avoid personal injury or propeller deformation.
  - Make sure that the propellers and motors are installed securely before each flight.
  - Only use official DJI propellers. DO NOT mix propeller types.
  - Propellers are consumable components. Purchase additional propellers if necessary.
  - Make sure that all propellers are in good condition before each flight. DO NOT use aged, chipped, or broken propellers. Clean the propellers with a soft, dry cloth if there is any foreign matter attached.
  - To avoid injury, stay away from rotating propellers or motors.
  - To avoid damaging the propellers, place the aircraft correctly during transportation or storage. DO NOT squeeze or bend the propellers. If propellers are damaged, the flight performance may be affected.
  - Make sure the motors are mounted securely and rotating smoothly. If the motor overloads or stalls during flight, land immediately.
  - DO NOT attempt to modify the structure of the motors.
  - DO NOT touch or let hands or body parts come in contact with the motors after flight, as they may be hot.
  - DO NOT block any of the ventilation holes on the motors or the body of the aircraft.
  - Make sure the ESCs sound normal when powered on.
-

## 5.8 Intelligent Flight Battery

### Notice

- 
-  • Read and strictly follow the instructions in this manual, in the *Safety Guidelines* and on the battery stickers before using the battery. You shall take full responsibility for all operations and usage.
- 
1. DO NOT charge an Intelligent Flight Battery immediately after flight as it may be too hot. Wait for the battery to cool down to the allowable charging temperature before charging again.
  2. To prevent damage, the battery only charges when the battery temperature is between 5° and 40° C (41° and 104° F). The ideal charging temperature is from 22° to 28° C (71.6° to 82.4° F). Charging at the ideal temperature range can prolong battery life. Charging stops automatically if the temperature of the battery cells exceeds 55° C (131° F) during charging.
  3. Low-Temperature Notice:
    - Batteries cannot be used in extremely low-temperature environments of lower than -10° C (14° F).
    - Battery capacity is significantly reduced when flying at low temperatures from -10° to 5° C (14° to 41° F). Make sure to fully charge the battery before takeoff. Hover the aircraft in place for a while to warm up the battery after takeoff.
    - It is recommended to warm up the battery to at least 10° C (50° F) before takeoff when flying in low-temperature environments. The ideal temperature to warm up the battery is above 20° C (68° F).
    - The reduced battery capacity in low-temperature environments reduces the wind speed resistance performance of the aircraft. Fly with caution.
    - Take extra caution when flying at a high elevation with a low temperature.
  4. A fully charged battery will automatically discharge when it is idle for a period of time. Note that it is normal for the battery to emit heat during the discharging process.
  5. Fully charge the battery at least once every three months to maintain battery health. If the battery is not used for an extended period, battery performance may be affected or may even cause permanent battery damage. If a battery has not been charged or discharged for three months or more, the battery will no longer be covered by the warranty.
  6. For safety purposes, keep the batteries at a low power level in transit. Before transportation, it is recommended to discharge the batteries to 30% or lower.

## Installing/Removing the Battery

### Installation

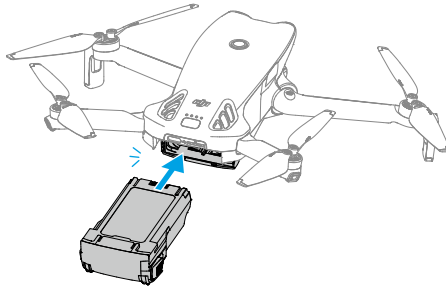

### Removal

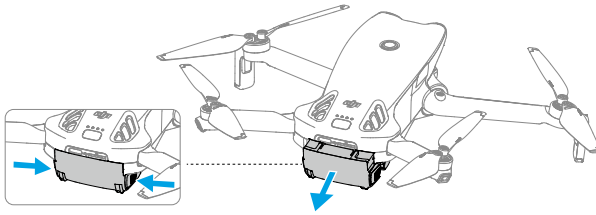

- 
- ⚠ • DO NOT insert or remove the battery while the aircraft is powered on.
- Make sure the battery is mounted securely with a clicking sound. DO NOT launch the aircraft when the battery is not securely mounted, as this may cause poor contact between the battery and the aircraft and present hazards.
- 

## Using the Battery



### Checking the Battery Level

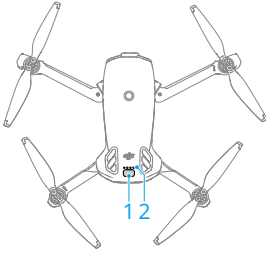







Press the power button once to check the current battery level.



1. Power Button
2. Battery Level LEDs

The battery level LEDs display the power level of the battery during charging and discharging. The statuses of the LEDs are defined below:

-  LED is on
-  LED is flashing
-  LED is off

Blinking Pattern	Battery Level
	88-100%
	76-87%
	63-75%
	51-62%
	38-50%
	26-37%
	13-25%
	0-12%

### Powering On/Off

Press, then press and hold the power button to power the aircraft on or off. The battery level LEDs display the battery level when the aircraft is powered on. The battery level LEDs turn off when the aircraft is powered off.

If the two LEDs shown in below picture blink simultaneously, it indicates the battery is malfunctioning. Remove the battery from the aircraft, insert the battery again and make sure that it is securely mounted.

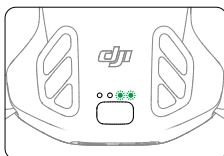

## Charging the Battery

Fully charge the battery before each use. It is recommended to use the charging devices provided by DJI or other chargers that support the USB PD fast charging protocol.

### Using a Charger

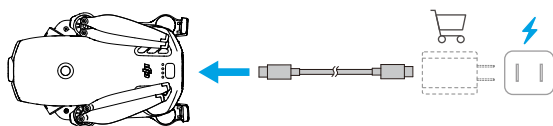

- 
- ⚠ • The battery cannot be charged if the aircraft is powered on.
- 

The table below shows the battery level during charging.

Blinking Pattern	Battery Level
	0-50%
	51-75%
	76-99%
	100%

- 
- 💡 • The blinking frequency of the battery level LEDs differs depending on the USB charger used. If the charging speed is fast, the battery level LEDs will blink quickly.
  - Four LEDs blinking simultaneously indicates the battery is damaged.
- 

## Using the Charging Hub



It is recommended to click the link below or scan the QR code to watch the tutorial video.



<https://www.dji.com/lito-x1/video>

- 
-  • The environmental temperature affects the charging speed. Charging is faster in a well-ventilated environment at 25° C (77° F).
- The charging hub is only compatible with a specific model of the Intelligent Flight Battery. DO NOT use the charging hub with other battery models.
  - Place the charging hub on a flat and stable surface when in use. Make sure the device is properly insulated to prevent fire hazards.
  - DO NOT touch the metal terminals on the battery ports.
  - Clean the metal terminals with a clean, dry cloth if there is any noticeable buildup.
- 

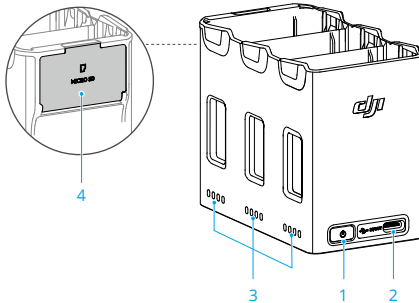

1. Function Button
2. USB-C Connector
3. Status LEDs
4. microSD Card Storage Slot (with cover)

## How to Charge

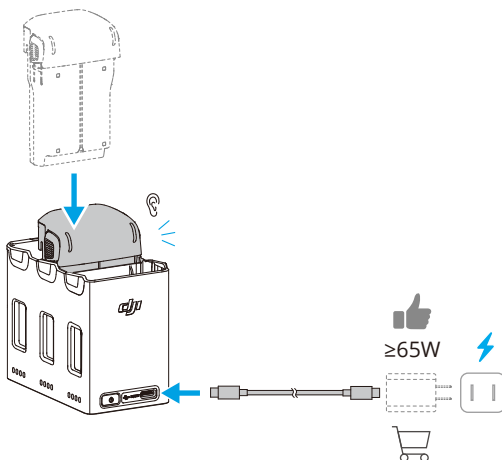

When using chargers of different power outputs, the charging sequence will vary.

Charger Power	Charging Sequence
<45 W	From highest to lowest battery level.
≥45 W	<b>Charges three batteries simultaneously<sup>[1]</sup>:</b> Charges the lowest-charged battery to closely match the second-highest one, then charges them to closely match the highest one, and finally charges all three batteries simultaneously.

[1] Parallel charging conditions:

- All batteries are of the same model.
- The charger supports USB Power Delivery (PD).

## Accumulating Power

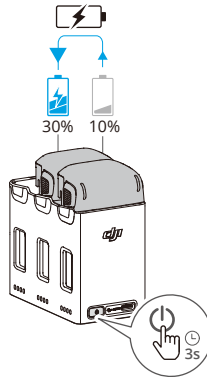

1. Insert the Intelligent Flight Batteries into the charging hub, press and hold the function button to transfer the power from the batteries with a lower power level to the battery with the highest power level. The status LEDs for the batteries with a lower power level will display the current power level, while the status LEDs for the battery with a high power level will blink in sequence.
2. To stop accumulating power, press and hold the function button again. After stopping power accumulation, press the function button to check the power level of the batteries.

- 
- ⚠** • Power accumulation stops automatically in the following situations:
- The receiving battery is fully charged, or the power of the output battery is lower than 5%.
  - A charger or external device is connected to the charging hub during power accumulation.
  - Power accumulation is interrupted for more than 15 minutes due to abnormal battery temperature.
  - After accumulating power, charge the battery with the lowest power level as soon as possible to avoid discharge.
- 

## Status LED Descriptions







Each battery port of the charging hub has its corresponding status LED array, which can indicate charging status, battery level and abnormal status. The LED status for battery level and battery abnormality is the same as that on the aircraft.

### Charging Status

Blinking Pattern	Descriptions
Status LEDs in an array blink quickly successively	The battery in the corresponding battery port is being charged using a USB PD charger.
Status LEDs in an array blink slowly successively	The battery in the corresponding battery port is being charged using a normal charger.
Status LEDs in an array are solid	The battery in the corresponding battery port is fully charged.
All status LEDs blink in sequence	No battery is inserted.

## Battery Protection Mechanisms

The battery level LEDs can display battery protection notifications triggered by abnormal charging conditions.

LEDs	Blinking Pattern	Status
	LED2 blinks twice per second	Overcurrent detected
	LED2 blinks three times per second	Short circuit detected
	LED3 blinks twice per second	Overcharge detected
	LED3 blinks three times per second	Over-voltage charger detected
	LED4 blinks twice per second	Charging temperature is too low
	LED4 blinks three times per second	Charging temperature is too high

If any of the battery protection mechanisms are activated, unplug the charger, and plug it in again to resume charging. If the charging temperature is abnormal, wait for it to return to normal. The battery will automatically resume charging without the need to unplug and plug in the charger again.

## 5.9 Gimbal and Camera

### Gimbal Notice

-  Make sure there are no stickers or objects on the gimbal before taking off. DO NOT tap or knock the gimbal after the aircraft is powered on. Launch the aircraft from open and flat ground to protect the gimbal.
- Remove the gimbal protector before powering on the aircraft. Attach the gimbal protector when the aircraft is not in use.

- Precision elements in the gimbal may be damaged by a collision or impact, which may cause the gimbal to function abnormally.
  - Avoid getting dust or sand on the gimbal, especially in the gimbal motors.
  - A gimbal motor may enter protection mode if the gimbal is obstructed by other objects when the aircraft is put on uneven ground or on grass, or if the gimbal experiences an excessive external force, such as during a collision. Wait for the gimbal to return to normal or restart the device.
  - DO NOT apply external force to the gimbal after the aircraft is powered on.
  - DO NOT add any extra payload other than an official accessory to the gimbal, as this may cause the gimbal to function abnormally or even lead to permanent motor damage.
  - Flying in heavy fog or clouds may make the gimbal wet, leading to temporary failure. The gimbal will recover full functionality once it is dry.
  - If there are strong winds, the gimbal may vibrate while recording.
  - After powering on, if the aircraft is not placed flat for an extended period or if it is significantly shaken, the gimbal may stop working and enter protection mode. In this case, place the aircraft flat and wait for it to recover.
  - DO NOT use the aircraft in rainy or snowy weather. If encountering rain or snow during flight, land the aircraft immediately and clean the surface of the gimbal and gimbal motor promptly.
  - If the gimbal tilt angle is large:
    - ◆ When the aircraft pitches forward due to forward acceleration or deceleration, the gimbal will enter limit protection mode and automatically adjust the angle downward.
    - ◆ When the aircraft rolls sideways due to lateral acceleration or deceleration, the gimbal yaw axis may reach movement limit.
    - ◆ The aircraft will restrict its speed to maintain image stabilization. In high wind conditions, flight speed will be further limited. Appropriately reducing the pitch angle can achieve higher flight speed.
    - ◆ The aircraft body may appear at the edge of the liveview.
- 

## Gimbal Angle

Use the gimbal dial on the remote controller to control the tilt of the gimbal. Alternatively, do so through the camera view in DJI Fly. Press and hold the screen until the gimbal adjustment bar appears. Drag the bar to control the gimbal's angle.

## Gimbal Operation Modes

Two gimbal operation modes are available. Switch between the different operation modes in \*\*\* > **Control**.

**Follow Mode:** The angle of the gimbal remains stable relative to the horizontal plane. This mode is suitable for capturing stable images.

**FPV Mode:** When the aircraft is flying forward, the gimbal rolls in sync with the rolling aircraft to provide a first-person flying experience.

## Camera Notice

---

- ⚠ • DO NOT expose the camera lens to an environment with laser beams, such as a laser show, or point the camera at intense light sources for an extended period of time, such as the sun on a clear day, in order to avoid damaging the sensor.
- Make sure the temperature and humidity are suitable for the camera during use and storage.
- Use a lens cleanser to clean the lens to avoid damage or poor image quality.
- DO NOT block any ventilation holes on the camera, as the heat generated may damage the device or cause injury.
- The cameras may not focus correctly in the following situations:
  - ◆ Capturing photos and videos of dark objects far away.
  - ◆ Capturing photos and videos of objects with repeating identical patterns and textures or objects without clear patterns or textures.
  - ◆ Capturing photos and videos of shiny or reflective objects (such as street lighting and glass).
  - ◆ Capturing photos and videos of flashing objects.
  - ◆ Capturing photos and videos of fast-moving objects.
  - ◆ When the aircraft/gimbal is moving fast.
  - ◆ Capturing photos and videos of objects with varying distances in the focus range.
- The aircraft uses SmartPhoto mode by default in Single Shot, which integrates features such as scene recognition or HDR for optimal results. SmartPhoto needs to take multiple shots continuously for image synthesis. When the aircraft is moving or using the 48MP resolution, SmartPhoto will not be supported, and the image quality will differ.
- The photos taken in Single Shot mode have no HDR effect in the following situations:

- When the aircraft or gimbal is moving, or if the aircraft is unable to hover stably due to high wind speeds.
- The camera is in Auto mode and the EV setting is adjusted manually.
- The camera is in Auto mode and the AE lock is turned on.
- The camera is in Pro mode.

## 5.10 Storing and Exporting Photos and Videos

### Storing

The aircraft supports the use of a microSD card to store your photos and videos. Refer to the Specifications for more information about recommended microSD cards.

Photos and videos can also be saved in the internal storage of the aircraft when no microSD card is available.

### Exporting

- Use QuickTransfer to export the footage to a mobile device.
- Connect the aircraft to a computer using a data cable, export the footage in the internal storage of the aircraft or in the microSD card mounted on the aircraft. The aircraft does not need to be powered on during the exporting process.
- Remove the microSD card from the aircraft and insert it into a card reader, and export the footage in the microSD card through the card reader.



- Ensure that the microSD card slot and the microSD card are clean and free of foreign objects during use.
- DO NOT remove the microSD card from the aircraft when taking photos or videos. Otherwise, the microSD card may be damaged.
- Check camera settings before use to ensure they are configured correctly.
- Before capturing important photos or videos, take a few images to test whether the camera is operating correctly.
- Make sure to power off the aircraft correctly. Otherwise, the camera parameters will not be saved, and any recorded images or videos may be affected. DJI is not responsible for any loss caused by an image or video recorded in a way that is not machine-readable.

## 5.11 QuickTransfer

Follow the steps below to quickly download photos and videos from the aircraft to your mobile device.

1. Power on the aircraft and wait until the self-diagnostic tests of the aircraft are complete.
2. Turn on the Bluetooth and Wi-Fi on the mobile device, and make sure the positioning function is enabled as well.
3. Enter QuickTransfer mode using one of the methods below.
  - Launch DJI Fly on the mobile device and tap the QuickTransfer card on the home screen.
  - Launch DJI Fly on the mobile device, go to Album, and tap  in the upper right corner.
4. Once successfully connected, the files on the aircraft can be accessed and downloaded at high speed. Note that when connecting the mobile device to the aircraft for the first time, press the power button of the aircraft to confirm.

### Allow QuickTransfer in Sleep

By default, QuickTransfer can be used when the aircraft is in sleep mode.

The aircraft enters sleep mode after powering off. The method for using QuickTransfer is the same in both power-off and power-on state.

If the mobile device and the aircraft are not connected via Wi-Fi or if the app is exited (and there are no ongoing download tasks) for more than 1 minute, QuickTransfer will automatically exit, and the aircraft will return to sleep mode. Sleep mode automatically turns off under the following circumstances:

- Aircraft is inactive for 12 hours.
- Battery is replaced.
- Aircraft is connected to another device via a USB-C cable.

To restore sleep mode, make sure there is no USB-C connection to the aircraft, and then press the power button once and wait for about 15 seconds.

During the process of restoring sleep mode and when using Allow QuickTransfer in Sleep for transmission, battery level LEDs 1&2 and LEDs 3&4 will blink alternately. If you unfold the right rear aircraft arm during this period, the aircraft will not power on.



-  • The maximum download rate can only be achieved in countries and regions where the 5.8 GHz frequency is permitted by laws and regulations, when using

devices that support 5.8 GHz frequency band and Wi-Fi connection, and in an environment without interference or obstruction. If 5.8 GHz is not allowed by local regulations (such as in Japan), or your mobile device does not support the 5.8 GHz frequency band, or the environment has severe interference, then QuickTransfer will use the 2.4 GHz frequency band and its maximum download rate will reduce to 8 MB/s.

- When using QuickTransfer, it is not necessary to enter the Wi-Fi password on the settings page of the mobile device in order to connect. Launch DJI Fly and a prompt will appear to connect the aircraft.
- Use QuickTransfer in an unobstructed environment with no interference and stay away from sources of interference such as wireless routers, Bluetooth speakers, or headphones.



- After the aircraft and the remote controller are connected, in the DJI Fly camera view, tap \*\*\* > **Camera** to enable or disable **Allow QuickTransfer in Sleep**.
-

# Remote Controller

---

## 6 Remote Controller

### 6.1 DJI RC 2

#### Operations

##### Powering On/Off

Press the power button once to check the current battery level.

Press, then press and hold to power the remote controller on or off.

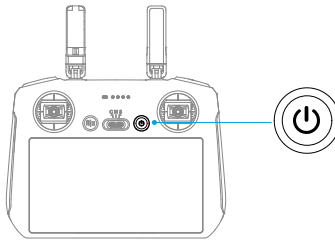

##### Charging the Battery

Connect the charger to the USB-C port on the remote controller.

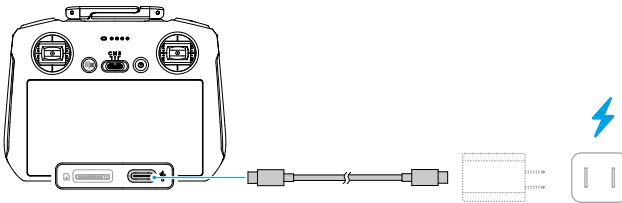

- ⚠️ Fully charge the remote controller before each flight. The remote controller sounds an alert when the battery level is low.
- Fully charge the battery at least once every three months to maintain the battery's health.

## Controlling the Gimbal and Camera

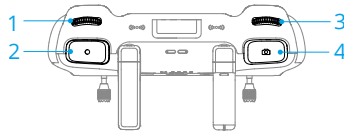

1. **Gimbal Dial:** Control the tilt of the gimbal.
2. **Record Button:** Press once to start or stop recording.
3. **Camera Control Dial:** Use to adjust the zoom by default. The dial function can be set to adjust the focal length, EV, shutter speed, and ISO.
4. **Focus/Shutter Button:** Press halfway down to auto-focus and press all the way down to take a photo.

## Flight Mode Switch

Toggle the switch to select the desired flight mode.

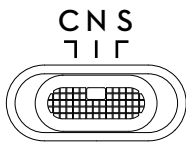

Position	Flight Mode
C	Cine Mode
N	Normal Mode
S	Sport Mode

## Flight Pause/RTH Button

Press once to make the aircraft brake and hover in place.

Press and hold the button until the remote controller beeps and starts RTH. The aircraft will return to the last recorded Home Point. Press the button again to cancel RTH and regain control of the aircraft.

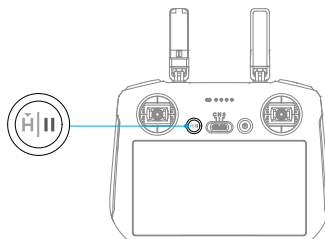

## Remote Controller LEDs

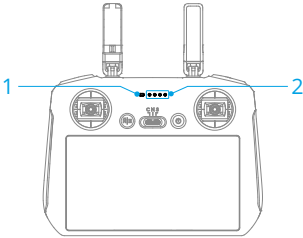

1. Status LED
2. Battery Level LEDs

### Status LED

Blinking Pattern	Descriptions
— Solid red	Disconnected from the aircraft.
..... Blinking red	The battery level of the aircraft is low.
— Solid green	Connected with the aircraft.
..... Blinking blue	The remote controller is linking to an aircraft.
— Solid yellow	Firmware update failed.
— Solid blue	Firmware update successful.
..... Blinking yellow	The battery level of the remote controller is low.
..... Blinking cyan	Control sticks not centered.

### Battery Level LEDs

Blinking Pattern	Battery Level
	76-100%
	51-75%
	26-50%
	0-25%

### Remote Controller Alert

The remote controller beeps to indicate an error or warning. Pay attention when prompts appear on the touchscreen or in DJI Fly.

Slide down from the top of the screen and select Mute to disable all alerts, or slide the volume bar to 0 to disable some alerts.

The remote controller sounds an alert during RTH, which cannot be cancelled. The remote controller sounds an alert when the battery level of the remote controller is low. A low battery level alert can be cancelled by pressing the power button. When the battery level is critically low, the alert cannot be cancelled.

There will be an alert if the remote controller is not used for a period of time while it is powered on but is not connected to the aircraft. It will automatically power off after the alert stops. Move the control sticks or press any button to cancel the alert.

## Optimal Transmission Zone

The signal between the aircraft and the remote controller is most reliable when the antennas are positioned in relation to the aircraft as illustrated below. If the signal is weak, adjust the remote controller orientation, or fly the aircraft closer to the remote controller.

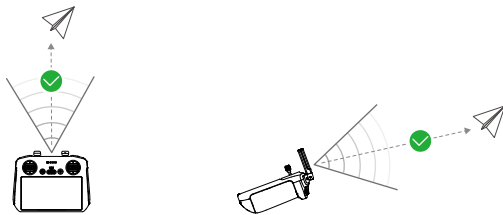

- 
- ⚠ • DO NOT use other wireless devices operating at the same frequency as the remote controller. Otherwise, the remote controller will experience interference.
  - A prompt will be displayed in DJI Fly if the transmission signal is weak during flight. Adjust the remote controller orientation according to the attitude indicator display to make sure that the aircraft is in the optimal transmission range.
- 

## Linking the Remote Controller

The remote controller is already linked to the aircraft when purchased together as a combo. Otherwise, follow the steps below to link the remote controller and the aircraft after activation.

1. Power on the aircraft and the remote controller.
2. Launch DJI Fly.

3. Tap **Connect to Aircraft** on the home screen, then select the corresponding aircraft model.
4. In camera view, tap \*\*\* > **Control** > **Connect to Aircraft**. During linking, the status LED of the remote controller blinks blue and the remote controller beeps.
5. Press and hold the power button of the aircraft for more than four seconds. The aircraft beeps, and its battery level LEDs blink in sequence to indicate it is ready to link. The remote controller will beep twice, and its status LED will turn solid green to indicate linking is successful.



- Make sure the remote controller is within 0.5 m of the aircraft during linking.
- The remote controller will automatically unlink from an aircraft if a new remote controller is linked to the same aircraft.

## Operating the Touchscreen



- Note that the touchscreen is not water-resistant. Operate with caution.

### Screen Gestures

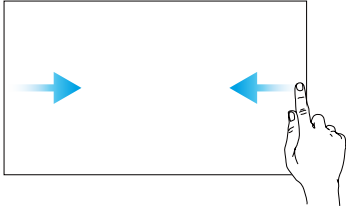

**Back:** Slide from the left or right to the center of the screen to return to the previous screen.

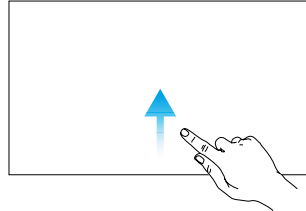

**Return to DJI Fly:** Slide up from the bottom of the screen to return to DJI Fly.

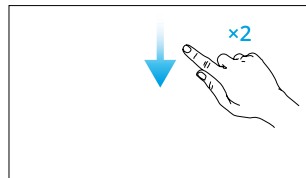
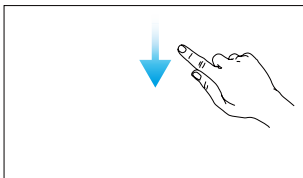

**Open the status bar:** Slide down from the top of the screen to open the status bar when in DJI Fly.

The status bar displays the time, Wi-Fi signal, battery level of the remote controller, etc.

**Open Quick Settings:** Slide down twice from the top of the screen to open Quick Settings when in DJI Fly.

## 6.2 DJI RC-N3

### Operations

#### Powering On/Off

Press the power button once to check the current battery level.

Press, then press and hold to power the remote controller on or off.

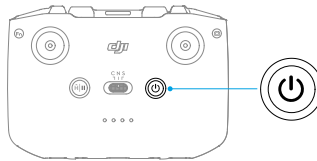

#### Charging the Battery

Connect the charger to the USB-C port on the remote controller.

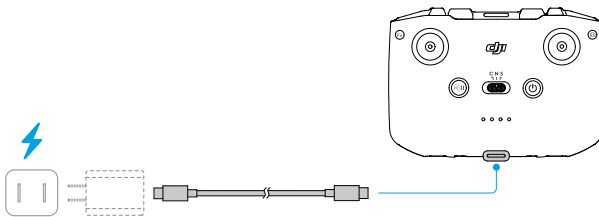

- 
- ⚠ • Fully charge the remote controller before each flight. The remote controller sounds an alert when the battery level is low.
  - Fully charge the battery at least once every three months to maintain the battery's health.
- 

#### Controlling the Gimbal and Camera

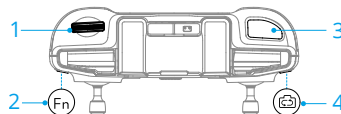

1. **Gimbal Dial:** Control the tilt of the gimbal.

2. **Customizable Button:** Press and hold the customizable button and then use the gimbal dial to zoom in or out.
3. **Shutter/Record Button:** Press once to take a photo or to start or stop recording.
4. **Photo/Video Button:** Press once to switch between photo and video mode.

## Flight Mode Switch

Toggle the switch to select the desired flight mode.

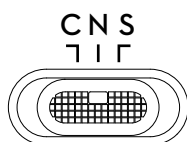

Position	Flight Mode
C	Cine Mode
N	Normal Mode
S	Sport Mode

## Flight Pause/RTH Button

Press once to make the aircraft brake and hover in place.

Press and hold the button until the remote controller beeps and starts RTH. The aircraft will return to the last recorded Home Point. Press the button again to cancel RTH and regain control of the aircraft.

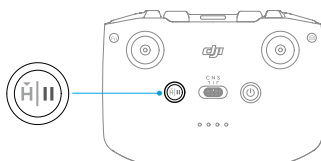

## Battery Level LEDs

Blinking Pattern	Battery Level
● ● ● ●	76-100%
● ● ● ○	51-75%
● ● ○ ○	26-50%
● ○ ○ ○	0-25%

## Remote Controller Alert

The remote controller sounds an alert during RTH, which cannot be cancelled. The remote controller sounds an alert when the battery level of the remote controller is low. A low battery level alert can be cancelled by pressing the power button. When the battery level is critically low, the alert cannot be cancelled.

There will be an alert if the remote controller is not used for a period while it is powered on but is not connected to the aircraft or the DJI Fly app on the mobile device. The remote controller will automatically power off after the alert stops. Move the control sticks or press any button to cancel the alert.

## Optimal Transmission Zone

The signal between the aircraft and the remote controller is most reliable when the antennas are positioned in relation to the aircraft as illustrated below. If the signal is weak, adjust the remote controller orientation, or fly the aircraft closer to the remote controller.

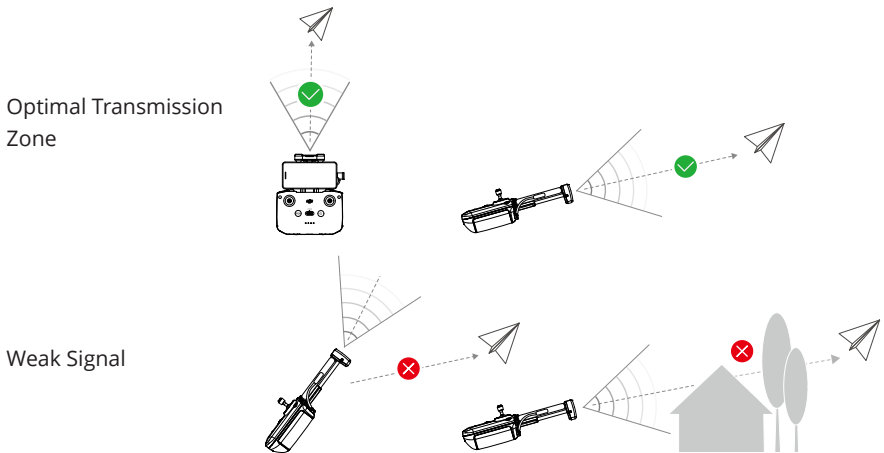

- ⚠ • DO NOT use other wireless devices operating at the same frequency as the remote controller. Otherwise, the remote controller will experience interference.
- A prompt will be displayed in DJI Fly if the transmission signal is weak during flight. Adjust the remote controller orientation according to the attitude indicator display to make sure that the aircraft is in the optimal transmission range.

## Linking the Remote Controller

The remote controller is already linked to the aircraft when purchased together as a combo. Otherwise, follow the steps below to link the devices.

1. Power on the aircraft and the remote controller.
2. Launch DJI Fly.
3. Tap **Connect to Aircraft** on the home screen, then select the corresponding aircraft model.
4. In camera view, tap \*\*\* > **Control** > **Connect to Aircraft**. During linking, the remote controller beeps.
5. Press and hold the power button of the aircraft for more than four seconds. The aircraft beeps, and its battery level LEDs blink in sequence to indicate it is ready to link. The remote controller will beep twice to indicate linking is successful.



- Make sure the remote controller is within 0.5 m of the aircraft during linking.
  - The remote controller will automatically unlink from an aircraft if a new remote controller is linked to the same aircraft.
-

# Appendix

---

## 7 Appendix

### 7.1 Specifications

Visit the following website for specifications.

<https://www.dji.com/lito-x1/specs>

### 7.2 Compatibility

Visit the following website to get the information on compatible products.

<https://www.dji.com/lito-x1/faq>

### 7.3 Firmware Update

Use DJI Fly or DJI Assistant 2 (Consumer Drones Series) to update the aircraft and the remote controller firmware.

#### Using DJI Fly

When the aircraft is connected to the remote controller, run DJI Fly, and you will be notified if a new firmware update is available. Follow the on-screen instructions for update. Note that you cannot update the firmware if the remote controller is not linked to the aircraft. An internet connection is required.

#### Using DJI Assistant 2 (Consumer Drones Series)

Use DJI Assistant 2 (Consumer Drones Series) to update the aircraft and the remote controller separately.

1. Power on the device. Connect the device to a computer with a USB-C cable.
2. Launch DJI Assistant 2 (Consumer Drones Series) and log in with your DJI account.
3. Select the device and click **Firmware Update** on the left side of the screen.
4. Select the firmware version.
5. Wait for the firmware to download. The firmware update will start automatically. Wait for the firmware update to complete.



- The battery firmware is included in the aircraft firmware. Be sure to update all batteries.
- Make sure to follow all the steps to update the firmware, otherwise the update may fail.

- Make sure the computer is connected to the internet during the update.
- DO NOT unplug the USB-C cable during an update.
- The firmware update will take approximately 10 minutes. During the update process, it is normal for the gimbal to go limp, the aircraft status indicators to blink, and the aircraft to reboot. Wait patiently for the update to complete.

Visit the following link and refer to the *Release Notes* for firmware update information:

<https://www.dji.com/lito-x1/downloads>

## 7.4 Flight Recorder

Flight data including flight telemetry, aircraft status information, and other parameters are automatically saved to the internal data recorder of the aircraft. The data can be accessed using DJI Assistant 2 (Consumer Drones Series).

## 7.5 Post-Flight Checklist

- Make sure to perform a visual inspection so that the aircraft, remote controller, gimbal camera, Intelligent Flight Batteries, and propellers are in good condition. Contact DJI support if any damage is noticed.
- Make sure that the camera lens and vision system sensors are clean.
- Make sure to store the aircraft correctly before transporting it.

## 7.6 Maintenance Instructions

To avoid serious injury to children and animals, observe the following rules:

1. Small parts, such as cables and straps, are dangerous if swallowed. Keep all parts out of reach of children and animals.
2. Store the Intelligent Flight Battery and remote controller in a cool, dry place away from direct sunlight to ensure the built-in LiPo battery does NOT overheat. Recommended storage temperature: between 22° and 28° C (71° and 82° F) for storage periods of more than three months. Never store in environments outside the temperature range of -10° to 45° C (14° to 113° F).
3. DO NOT allow the camera to come into contact with or become immersed in water or other liquids. If it gets wet, wipe dry with a soft, absorbent cloth. Turning on an aircraft that has fallen in water may cause permanent component damage. DO NOT

use substances containing alcohol, benzene, thinners, or other flammable substances to clean or maintain the camera. DO NOT store the camera in humid or dusty areas.

4. Check every aircraft part after any crash or serious impact. If there are any problems or questions, contact a DJI authorized dealer.
5. Regularly check the Battery Level Indicators to see the current battery level and overall battery life. The battery is rated for 200 cycles. It is not recommended to continue use afterward.
6. Make sure to transport the aircraft with the arms folded when powered off.
7. Make sure to transport the remote controller with antennas folded when powered off.
8. The battery will enter sleep mode during long-term storage. Charge the battery to exit from sleep mode.
9. Store the aircraft, remote controller, battery, and charger in a dry environment.
10. Remove the battery before servicing the aircraft (e.g., cleaning or attaching and detaching the propellers). Make sure that the aircraft and the propellers are clean by removing any dirt or dust with a soft cloth. Do not clean the aircraft with a wet cloth or use a cleanser that contains alcohol. Liquids can penetrate the aircraft housing, which can cause a short circuit and destroy the electronics.

## 7.7 Troubleshooting Procedures

### 1. How to solve the gimbal drift issue during flight?

Calibrate IMU and compass in DJI Fly. If the problem persists, contact DJI Support.

### 2. No function

Check if the Intelligent Flight battery and the remote controller are activated by charging. If the problems persist, contact DJI Support.

### 3. Power-on and start-up problems

Check if the battery has power. If yes, contact DJI Support if it cannot be started normally.

### 4. Firmware update issues

Follow the instructions in the user manual to update the firmware. If the firmware update fails, restart all the devices and try again. If the problem persists, contact DJI Support.

### 5. Procedures to reset to factory default

Use the DJI Fly app to reset to factory default settings.

### 6. Shutdown and power-off problems

Contact DJI Support.

## 7. How to detect careless handling or storage in unsafe conditions

Contact DJI Support.

## 7.8 Risks and Warnings

When the aircraft detects a risk after powering on, there will be a warning prompt on DJI Fly. Pay attention to the list of situations below.

- If the location is not suitable for takeoff.
- If an obstacle is detected during flight.
- If the location is not suitable for landing.
- If the compass and IMU experience interference and need to be calibrated.
- Follow the on-screen instructions when prompted.

## 7.9 Disposal



Observe the local regulations related to electronic devices when disposing of the aircraft and remote controller.

### Battery Disposal

Dispose of the batteries in specific recycling containers only after a complete discharge. DO NOT dispose of the batteries in regular trash containers. Strictly follow the local regulations regarding the disposal and recycling of batteries.

Dispose of a battery immediately if it cannot be powered on after over-discharging.

If the power button is disabled and the battery cannot be fully discharged, contact a professional battery disposal/recycling agency for further assistance.

## 7.10 C0 and C1 Certification

DJI Lito X1 is compliant with C0 and C1 certification requirements. There are some requirements and restrictions when using DJI Lito X1 in EU member states, EFTA member states (EFTA, i.e. Norway, Iceland, Liechtenstein, Switzerland) and Georgia.

Model	DGP14C
-------	--------

UAS Class	C0
Maximum Take-Off Mass (MTOM)	249 g
Maximum Propeller Speed	12874 RPM
Model	DGP14D
UAS Class	C1
Maximum Take-Off Mass (MTOM)	340 g
Sound Power Level	81 dB
Maximum Propeller Speed	12874 RPM

## MTOM Statement

### For C0

The MTOM of DJI Lito X1 (Model: DGP14C) is 249 g to comply with C0 requirements.

### For C1

The MTOM of DJI Lito X1 (Model: DGP14D) is 340 g to comply with C1 requirements.

You must follow the instructions below to comply with the MTOM requirements.

- DO NOT add any payload to the aircraft except the items listed in the List of Items including qualified accessories section.
- DO NOT use any non-qualified replacement parts, such as intelligent flight batteries or propellers, etc.
- DO NOT retrofit the aircraft.

## List of Items, including qualified accessories

### For C0

Item	Model Number	Dimensions	Weight
Propellers	6030F	152.4×76.2 mm (diameter×thread pitch)	0.9 g (each piece)
Intelligent Flight Battery	BWXGP1-2788-7.0	85.99×54.89×24.80 mm	Approx. 71.2 g
ND Filters Set <sup>[1]</sup> (ND 16/64/256)	N/A	19.6×14.2×4.6 mm	0.34 g (individual)
microSD Card <sup>[2]</sup>	N/A	15×11×1.0 mm	Approx. 0.3 g

### For C1

Item	Model Number	Dimensions	Weight
Propellers	6030F	152.4×76.2 mm (diameter×thread pitch)	0.9 g (each piece)
Intelligent Flight Battery	BWXGP1-2788-7.0	85.99×54.89×24.80 mm	Approx. 71.2 g
Intelligent Flight Battery Plus <sup>[3]</sup>	BWXGP1-4680-7.16	85.99×54.89×24.80 mm	Approx. 118.4 g
Propeller Guards <sup>[2]</sup>	DGP14D-PPG	350×162×59 mm (one side)	47 g (one side)
ND Filters Set <sup>[1]</sup> (ND 16/64/256)	N/A	19.6×14.2×4.6 mm	0.34 g (individual)
microSD Card <sup>[2]</sup>	N/A	15×11×1.0 mm	Approx. 0.3 g

[1] The ND filter set may not be included in the original packaging. For how to install and use the ND Filters Set, refer to the ND Filter Set Product Information.

[2] Not included in the original packaging.

[3] Only sold in some countries and regions.

## List of Spare and Replacement Parts

### For C0

- Propellers (Model: 6030F)
- DJI Lito X1 Intelligent Flight Battery (Model: BWXGP1-2788-7.0)

### For C1

- Propellers (Model: 6030F)
- DJI Lito X1 Intelligent Flight Battery (Model: BWXGP1-2788-7.0)
- DJI Lito Series Intelligent Flight Battery Plus (Model: BWXGP1-4680-7.16)

## Direct Remote ID

- Transport Method: Wi-Fi Beacon.
- Method of uploading the UAS Operator Registration Number to the aircraft: Enter DJI Fly, tap \*\*\* > Safety > UAS Remote Identification, and then upload UAS operator registration number.

## Remote Controller Warnings

### DJI RC-N3

The battery level LEDs will start blinking slowly after disconnecting from the aircraft. DJI Fly will issue a warning prompt after disconnecting from the aircraft. The remote controller will beep and power off automatically after disconnecting from the aircraft and with no operation for a long time.



- Avoid interference between the remote controller and other wireless equipment. Make sure to turn off the Wi-Fi on nearby mobile devices. Land the aircraft as soon as possible if there is interference.
  - Release the control sticks or press the flight pause button if an unexpected operation occurs.
- 

## GEO Awareness

GEO Awareness contains the features listed below.

UGZ (Unmanned Geographical Zone) Data update: You can update the FlySafe data by using the data update feature automatically or storing the data in the aircraft manually.

- Method 1: Go to Settings in DJI Fly and tap **About > FlySafe Data > Check for Updates** to update the FlySafe data automatically.
- Method 2: Check the website of your national aviation authority regularly and obtain latest UGZ data to import to your aircraft. Go to Settings in DJI Fly, tap **About > FlySafe Data > Import from Files**, and then follow the on-screen instructions to store and import the UGZ data manually.



A prompt will appear in the DJI Fly app when the import completes successfully. If the import fails due to improper data format, follow the on-screen prompt and retry.

---

GEO Awareness Map Drawing: After the latest UGZ data is updated, a flight map with a restricted zone will be displayed in the DJI Fly app. Name, effective time, height limit, etc., can be viewed by tapping the area.

### AGL (Above Ground Level) Statement

The vertical part of Geo-Awareness may use the AMSL altitude or the AGL height. The choice between these two references is specified individually for each UGZ. Neither AMSL altitude nor the AGL height is supported by DJI Lito X1. The height H appears in the DJI Fly app camera view, which is the height from the aircraft takeoff point to the aircraft. The height above the takeoff point may be used as an approximation but may differ more or less from the given altitude/height for a specific UGZ. The remote pilot remains responsible for not breaching the vertical limits of the UGZ.

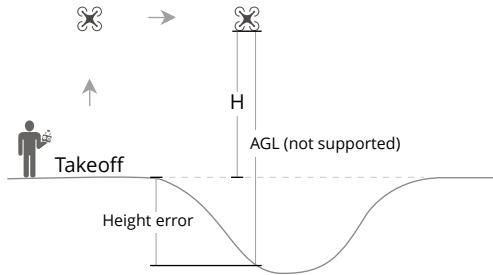

## GEO Zones

### Restricted Zones

Appear red in the DJI app. You will be prompted with a warning, and flight is prevented. UA cannot fly or take off in these zones. Restricted Zones may be unlocked, to unlock contact [flysafe@dji.com](mailto:flysafe@dji.com) or go to [Unlock A Zone at dji.com/flysafe](https://www.dji.com/unlock-a-zone).

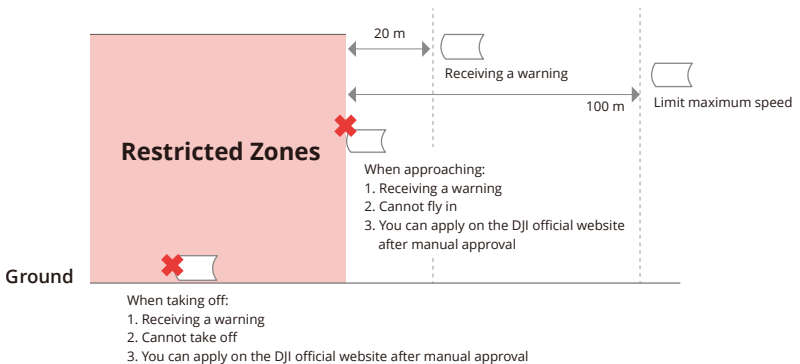

### Authorization Zones

Appear blue in the DJI app. You will be prompted with a warning, and flight is limited by default. UA cannot fly or take off in these zones unless authorized. Authorization Zones may be unlocked by authorized users using a DJI verified account.

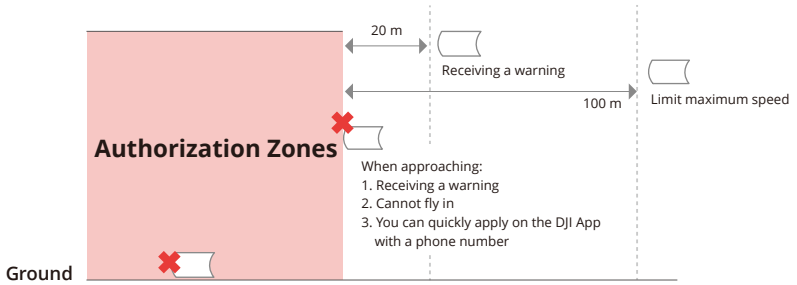

### Altitude Zones

Altitude zones are zones with a limited altitude and appear in gray on the map. When approaching, you will receive a warning in the DJI app.

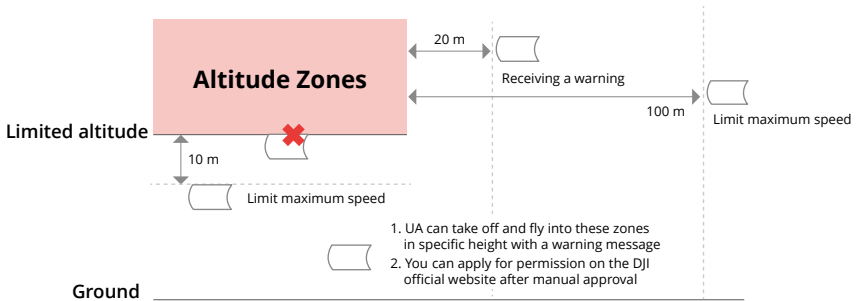

### Enhanced Warning Zones

A warning message will appear when the drone reaches the edge of the zone.

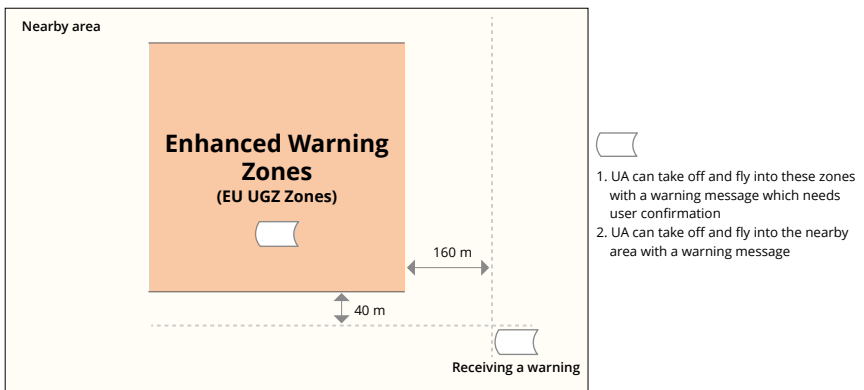

## Warning Zones

A warning message will prompt you when the drone reaches the edge of the zone.

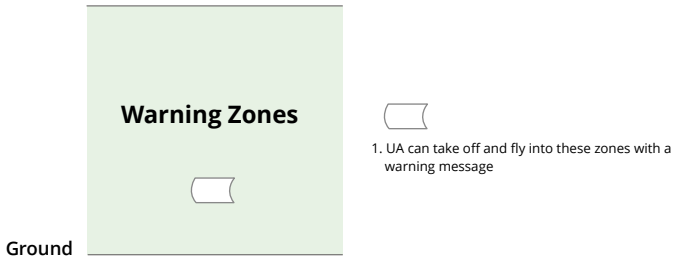

- 
- ⚠ • When the aircraft and DJI Fly app cannot obtain a GPS signal, the GEO awareness function will be inoperative. Interference of the aircraft antenna or disabling the GPS authorization in DJI Fly will cause the GPS signal fails to be obtained.
- 

## EASA Notice

Make sure to read the Drone Information Notices document included in the package before use.

Visit the link below for more EASA notice information on traceability.

<https://www.easa.europa.eu/en/document-library/general-publications/drones-information-notices>

## Original Instructions

This manual is provided by SZ DJI Technology, Inc., and the content is subject to change.

Address: Lobby of T2, DJI Sky City, No. 53 Xianyuan Road, Xili Community, Xili Street, Nanshan District, Shenzhen, China, 518055.

## 7.11 Aftersales Information

Visit <https://www.dji.com/support> to learn more about aftersales service policies, repair services, and support.



Contact  
DJI SUPPORT

This content is subject to change without notice.  
Download the latest version from



<https://www.dji.com/lito-x1/downloads>

If you have any questions about this document, please contact DJI by sending a message to [DocSupport@dji.com](mailto:DocSupport@dji.com).

DJI and DJI LITO are trademarks of DJI.  
Copyright © 2026 DJI All Rights Reserved.